Final results from TWIST

WNPPC 2010, Banff, Alberta

**James Bueno, University of British Columbia
on behalf of the TWIST collaboration**



- Apparatus improvements
- Systematic uncertainties for ρ and δ
- Systematic uncertainties for $P_{\mu\xi}$
- Quality of data
- The final results

First announcement outside of TRIUMF

- Implications for the Standard Model

TRIUMF Weak Interaction Symmetry Test

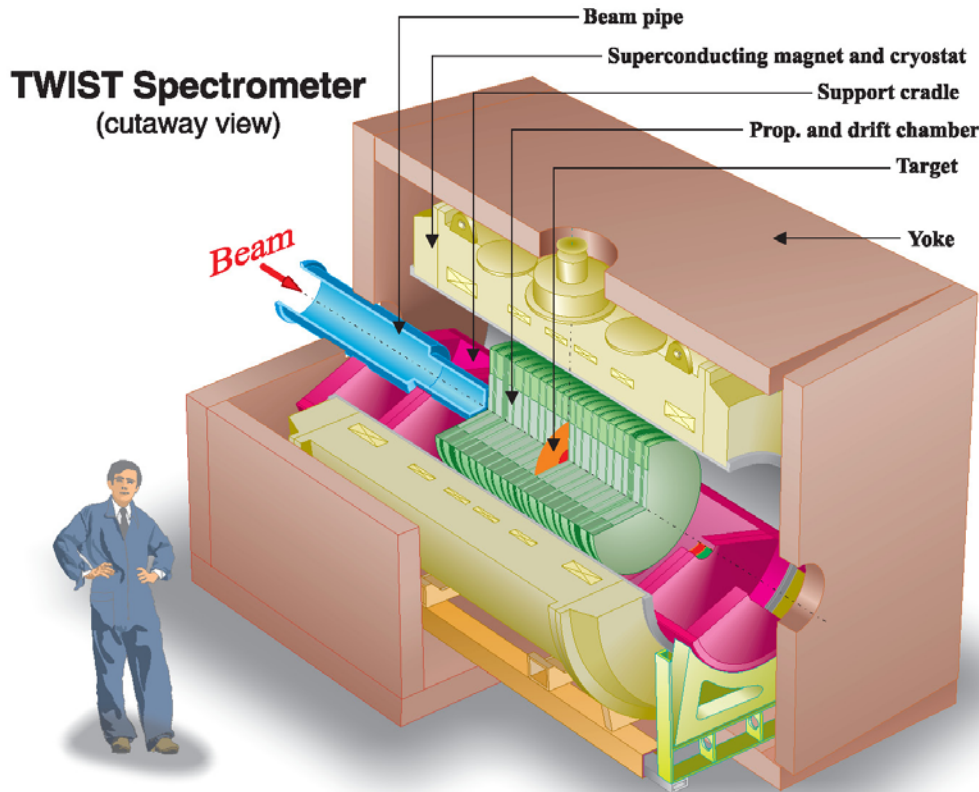

- Highly polarised μ^+ stopped in centre of symmetric detector.
- e^+ tracked in uniform magnetic field.
- Measures muon decay parameters by comparison to a detailed GEANT3 simulation.
- Final data acquired in 2006/2007.

Nucl. Instr. and Meth.
A548 (2005) 306-335

Jan 2010: Analysis complete

M13 beam line improvements

Nucl. Instr. and Meth.
A566 (2006) 563-574

Stopping target

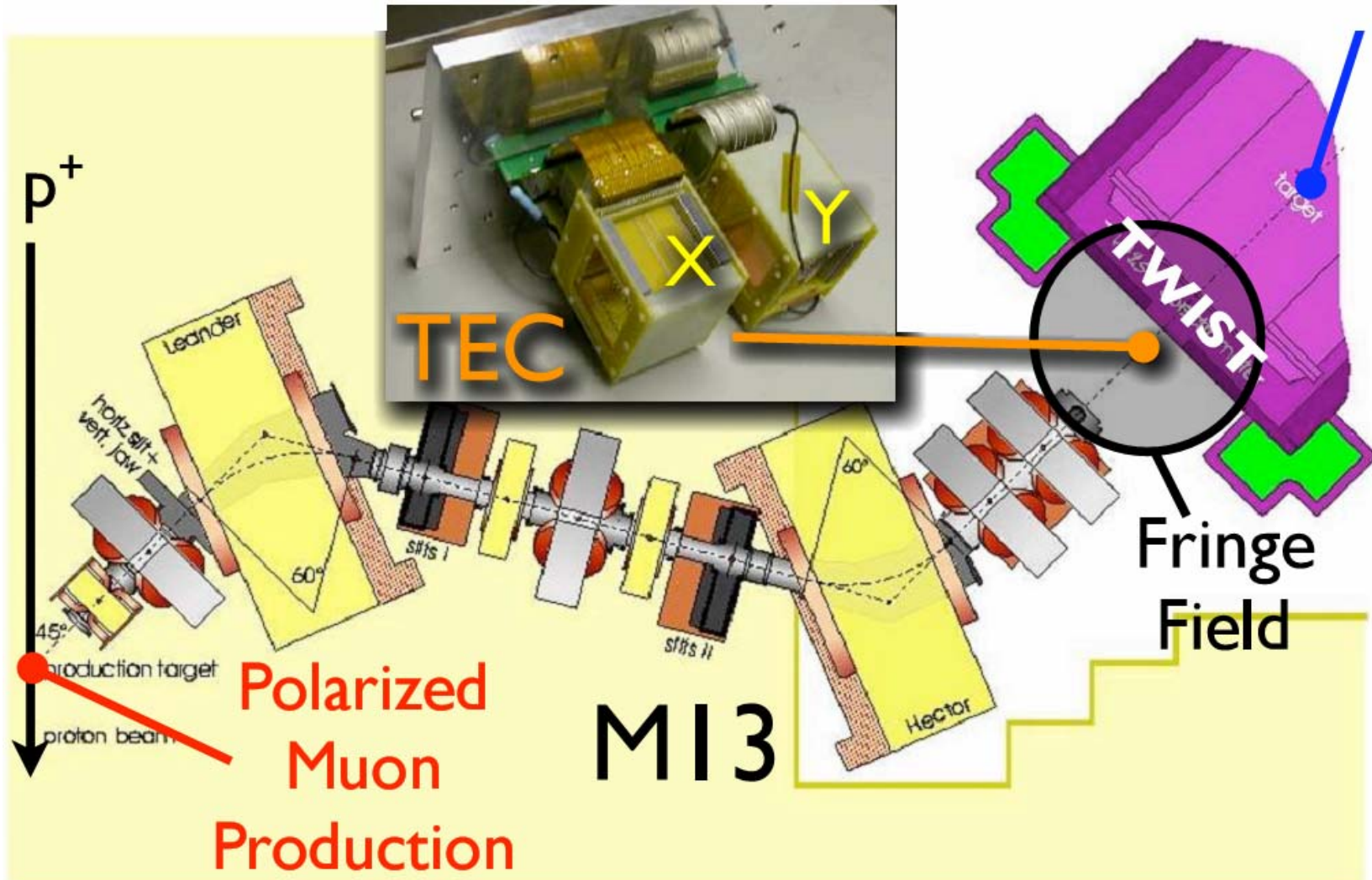

M13 beam line improvements

Nucl. Instr. and Meth.
A566 (2006) 563-574

Improved engineering of
TECs

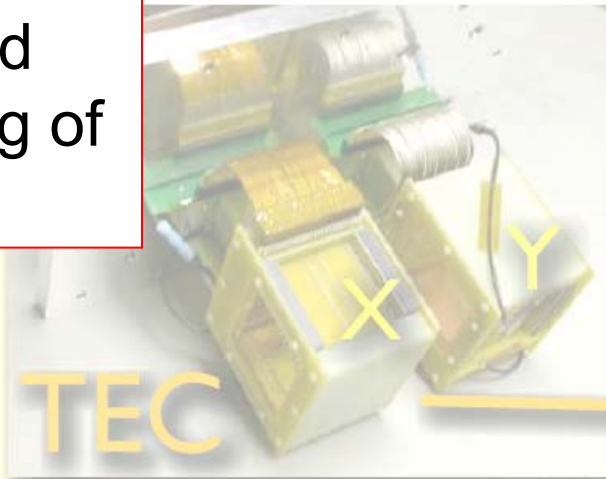

Stopping target

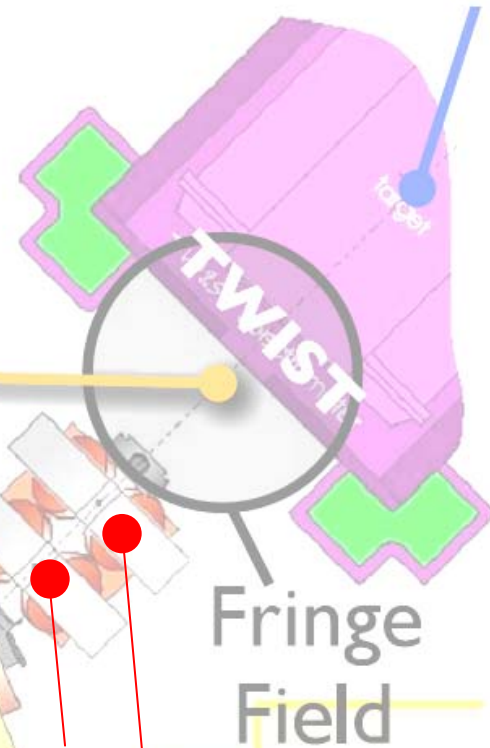

Muons selected
from different
depths

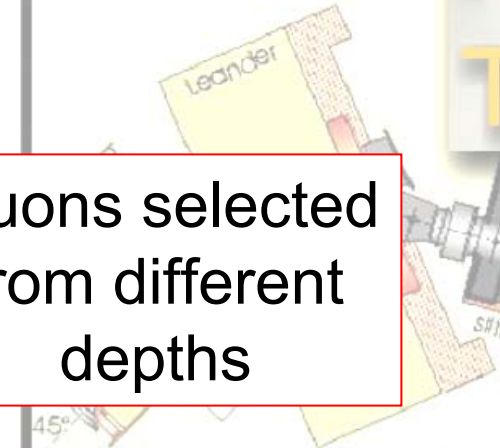

Polarized
Muon
Production

Beamline upgraded:
“quadrupole steering”
added

Spectrometer improvements

4

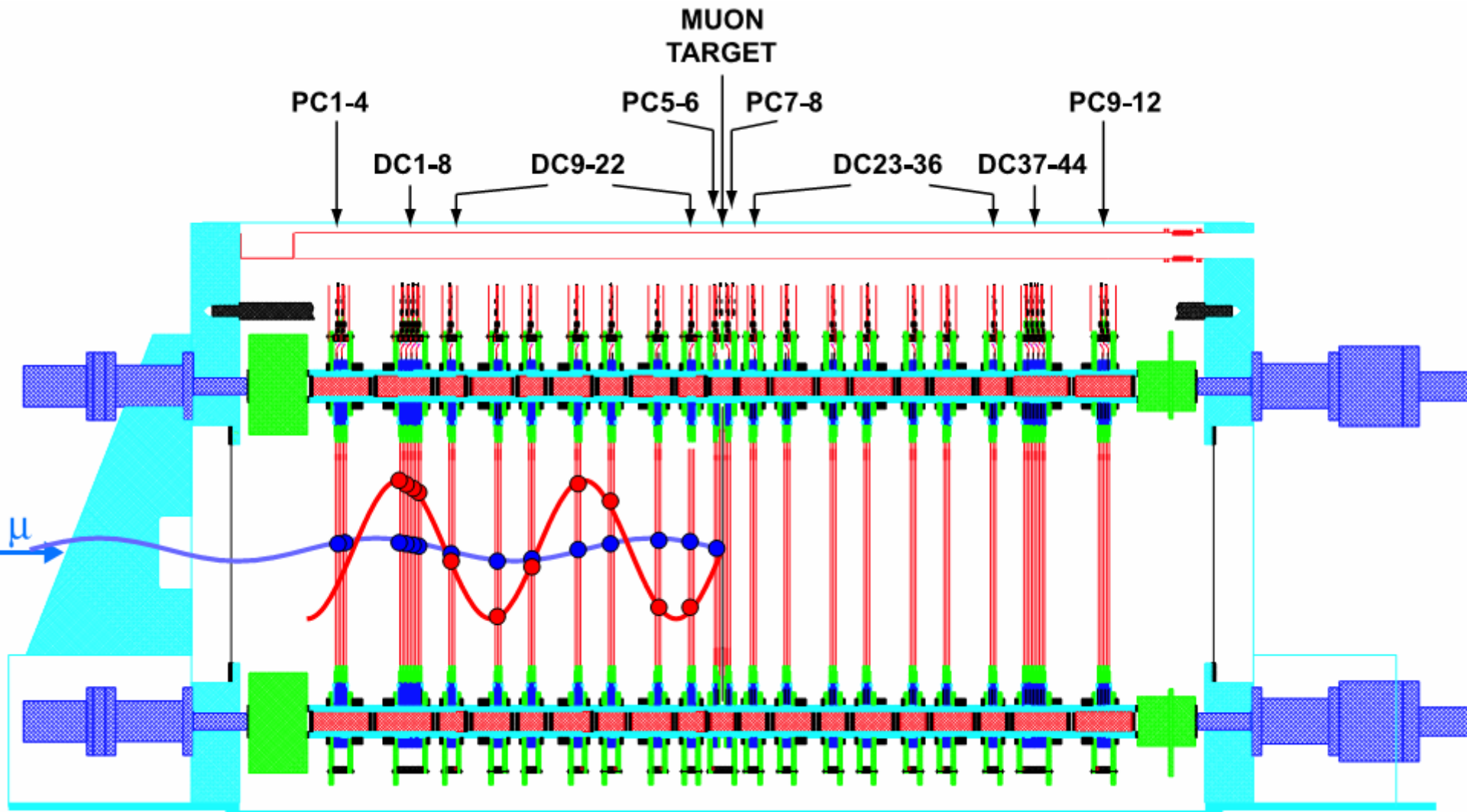

Nucl. Instr. and Meth. A548 (2005) 306-335

James Bueno, WNPPC 2010, Banff, Alberta

Spectrometer improvements

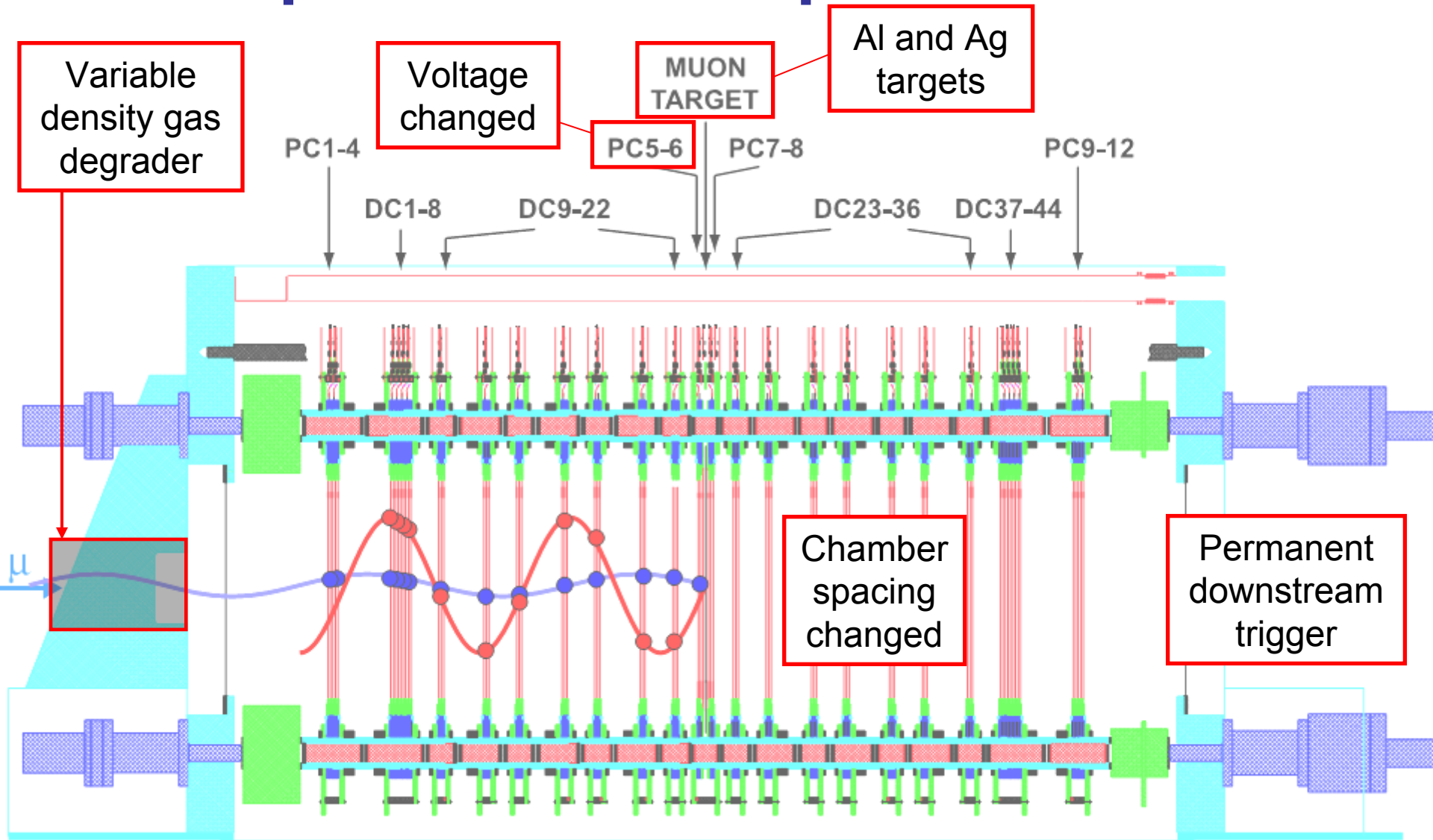

Nucl. Instr. and Meth. A548 (2005) 306-335

James Bueno, WNPPC 2010, Banff, Alberta

Final uncertainties for ρ and δ

Uncertainties	ρ (10^{-4})	δ (10^{-4})
Positron interactions	1.9	1.6
External uncertainties	1.3	0.6
Momentum calibration	1.2	1.2
Chamber response	1.0	1.8
Resolution	0.6	0.7
Spectrometer alignment	0.2	0.4
Beam stability	0.2	0.0
Statistical uncertainty	0.9	1.6
<i>Total in quadrature</i>	3.0	3.3

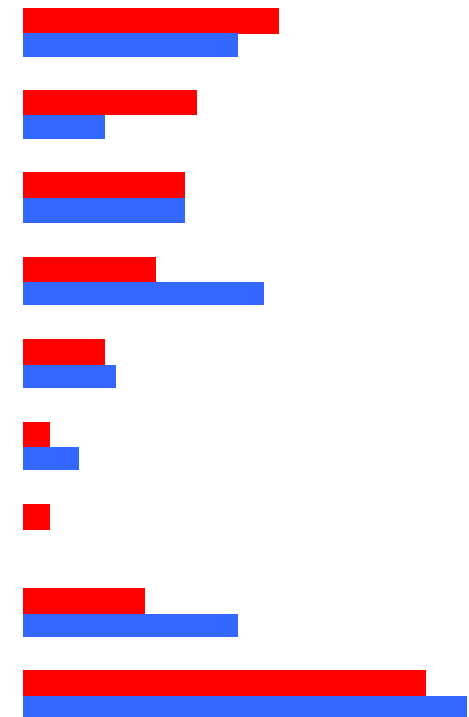

includes uncertainty due to radiative corrections

Positron interactions

6

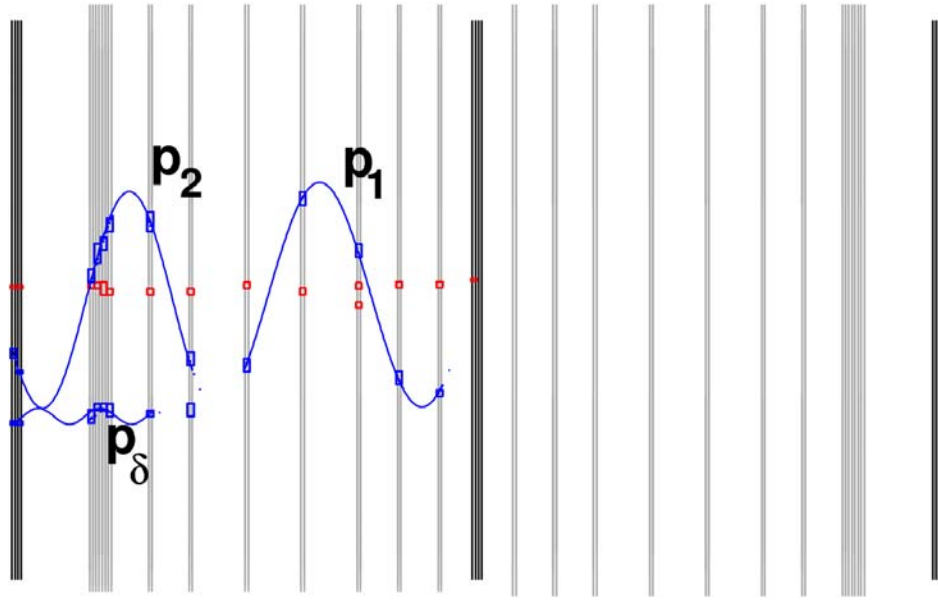

“Broken tracks”:

δ -electrons: 2 x e^+ , 1 x e^-
Bremsstrahlung: 2 x e^+

δ -electrons: data/sim agree $< 1\%$

Brem: data/sim differ by $\approx 2.4\%$

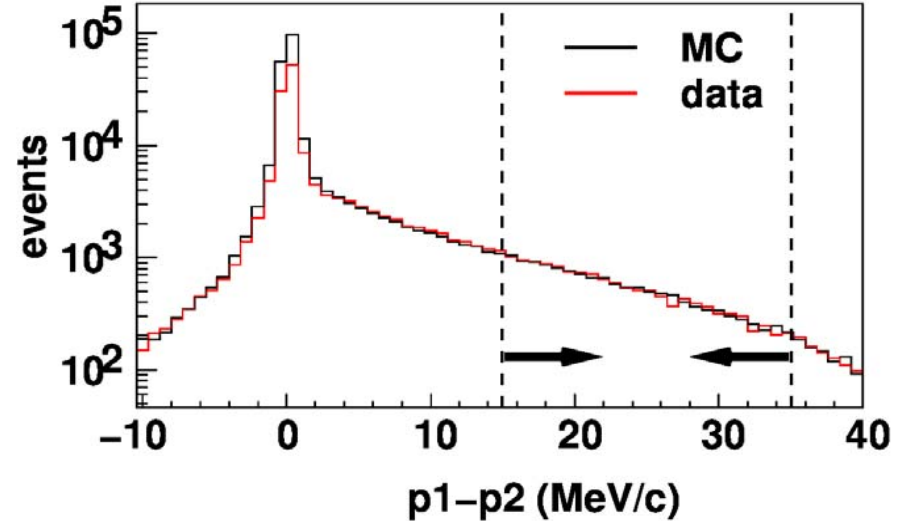
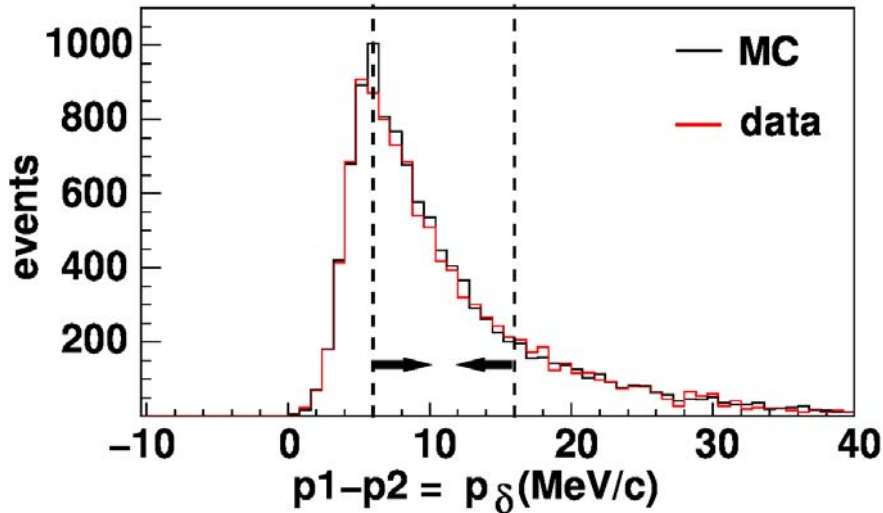

Momentum calibration

Spectrum endpoint provides a calibration

$-0.896 < \cos\theta < -0.848$

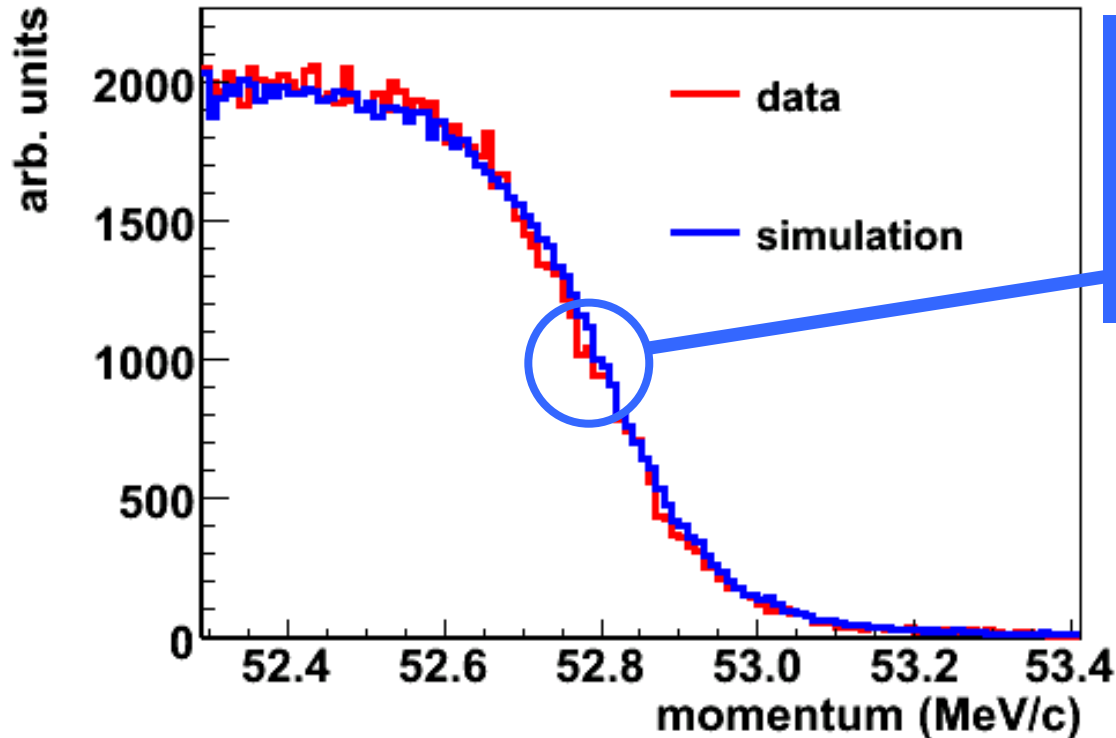

Simulation and data p_{\max} differ by ≈ 10 keV/c

Difference must be propagated to rest of spectrum

Momentum calibration

8

Extremes are application as a shift and scale

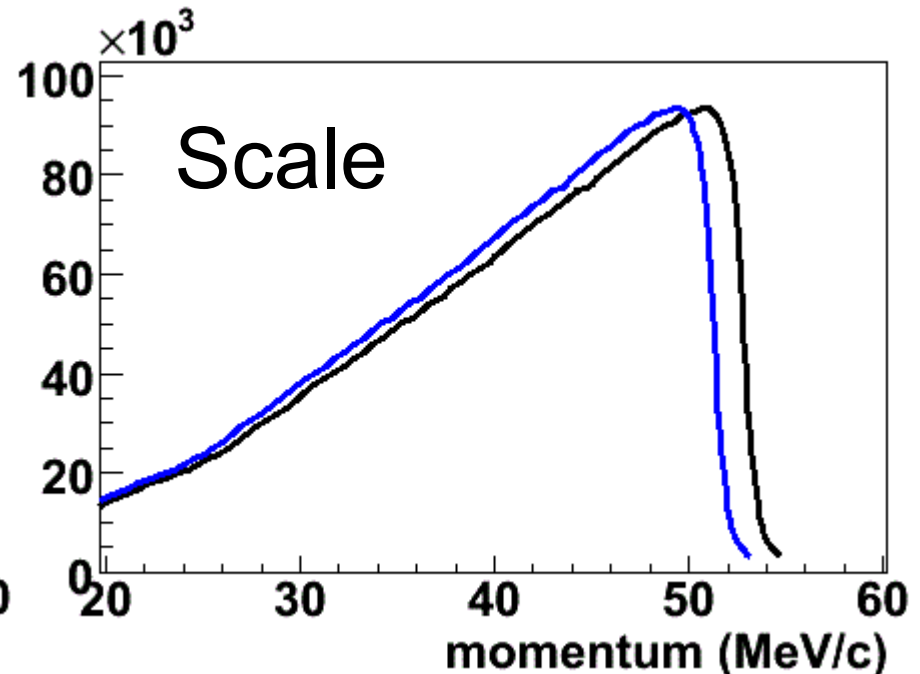
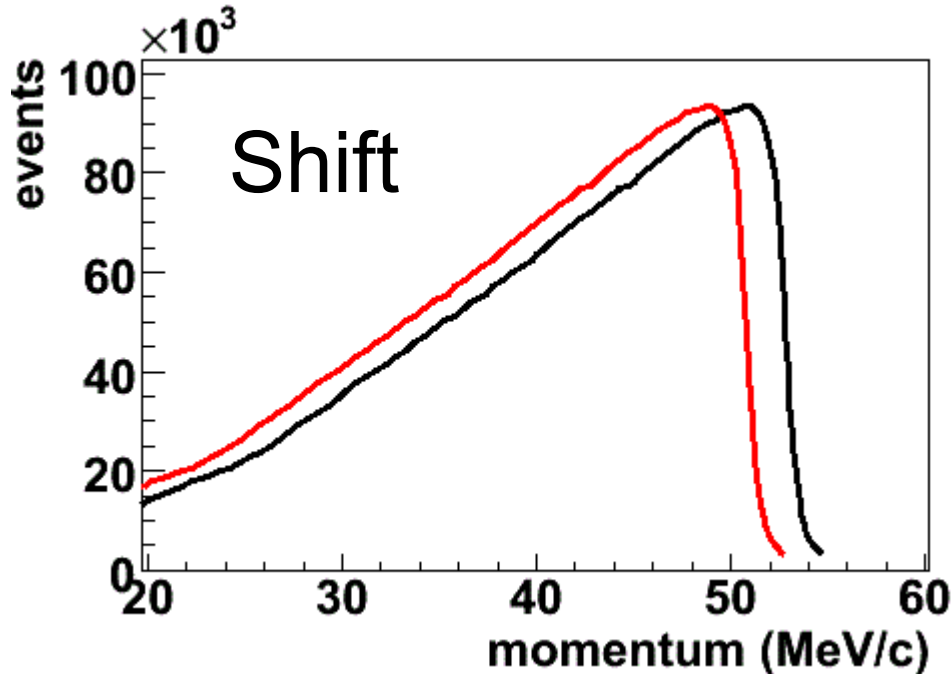

Difference between these choices gives
uncertainties of
 1.0×10^{-4} for ρ , and 1.1×10^{-4} for δ .

Chamber response

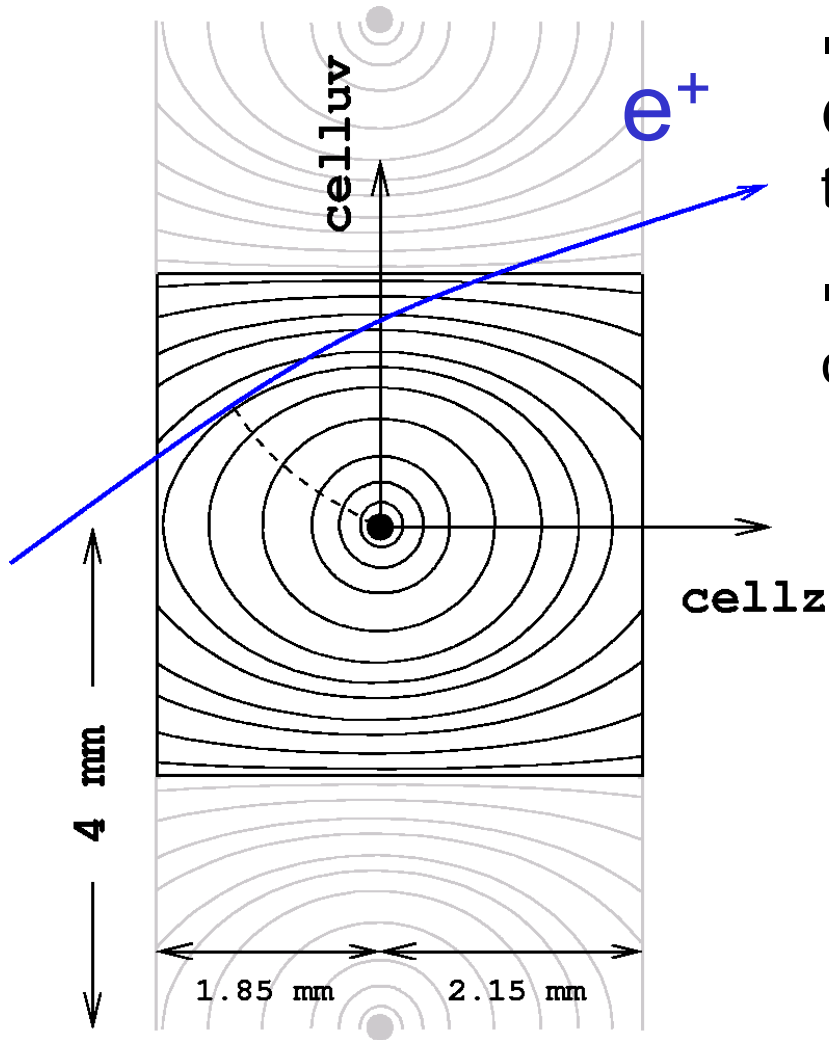

- Space-time relationship from GARFIELD is now refined to minimise track fit residuals.
- Corrects for plane-to-plane construction differences, tracking bias.

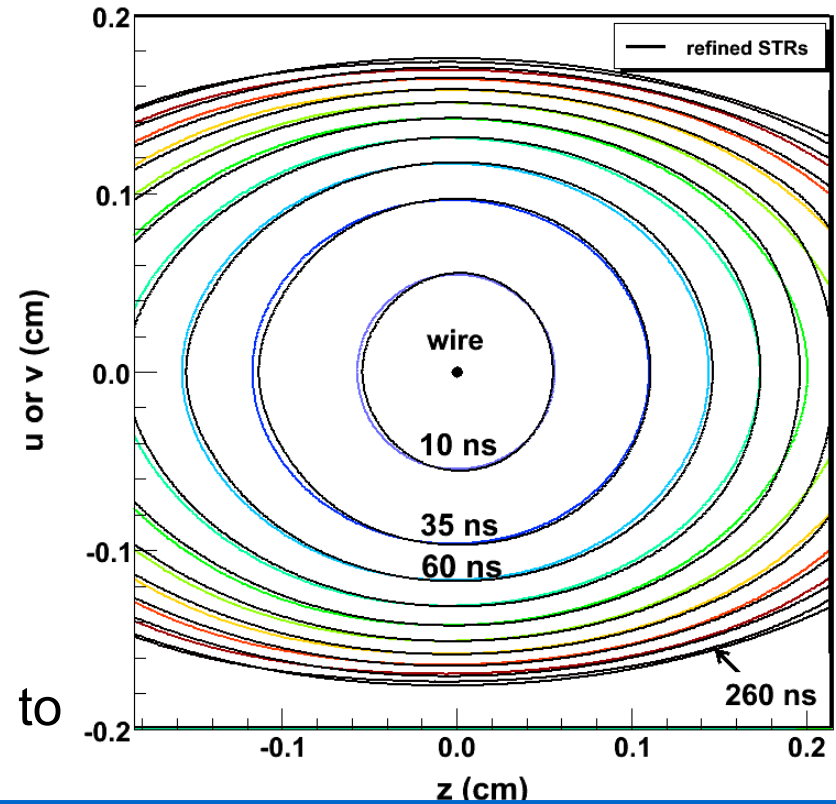

(paper describing technique is submitted to Nucl. Instr. and Meth. A)

Uncertainties for $P_{\mu}\xi$

10

Uncertainties	$P_{\mu}\xi$ (10^{-4})
Muon beam and fringe field	+ 15.8, - 4.0
Depol. in stopping target	3.2
Depol. in production target	0.3
Background muons	1.0
Chamber response	2.3
Resolution	1.5
Momentum calibration	1.5
External uncertainties	1.2
Positron interactions	0.7
Beam stability	0.3
Spectrometer alignment	0.2
Statistical uncertainty	3.5
<i>Total in quadrature</i>	+ 16.9, - 7.2

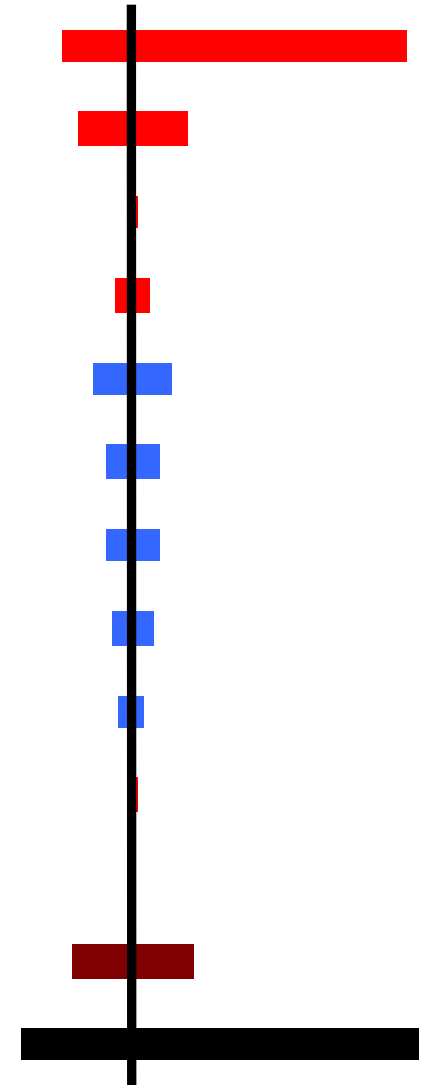

Uncertainties for $P_{\mu}\xi$

10

Uncertainties	$P_{\mu}\xi$ (10^{-4})
Muon beam and fringe field	+ 15.8, - 4.0
Depol. in stopping target	3.2
Depol. in production target	0.3
Background muons	1.0
Chamber response	2.3
Resolution	1.5
Momentum calibration	1.5
External uncertainties	1.2
Positron interactions	0.7
Beam stability	0.3
Spectrometer alignment	0.2
Statistical uncertainty	3.5
<i>Total in quadrature</i>	+ 16.9, - 7.2

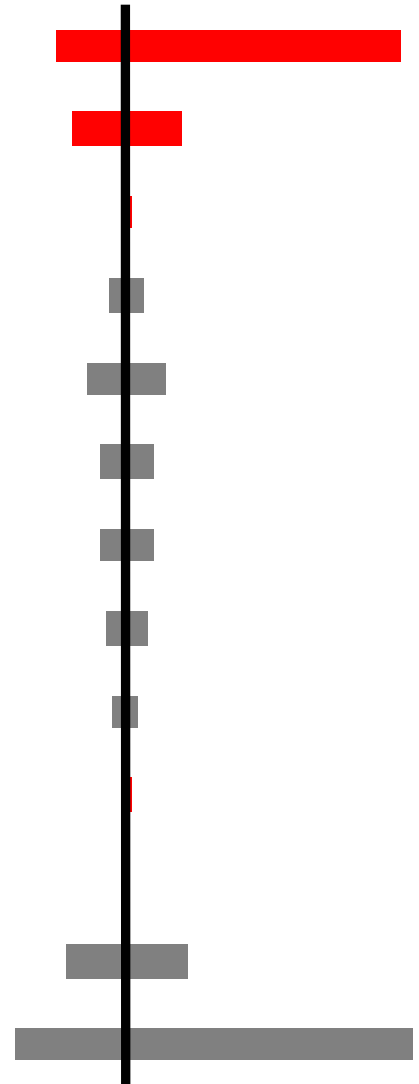

Muon beam and fringe field

11

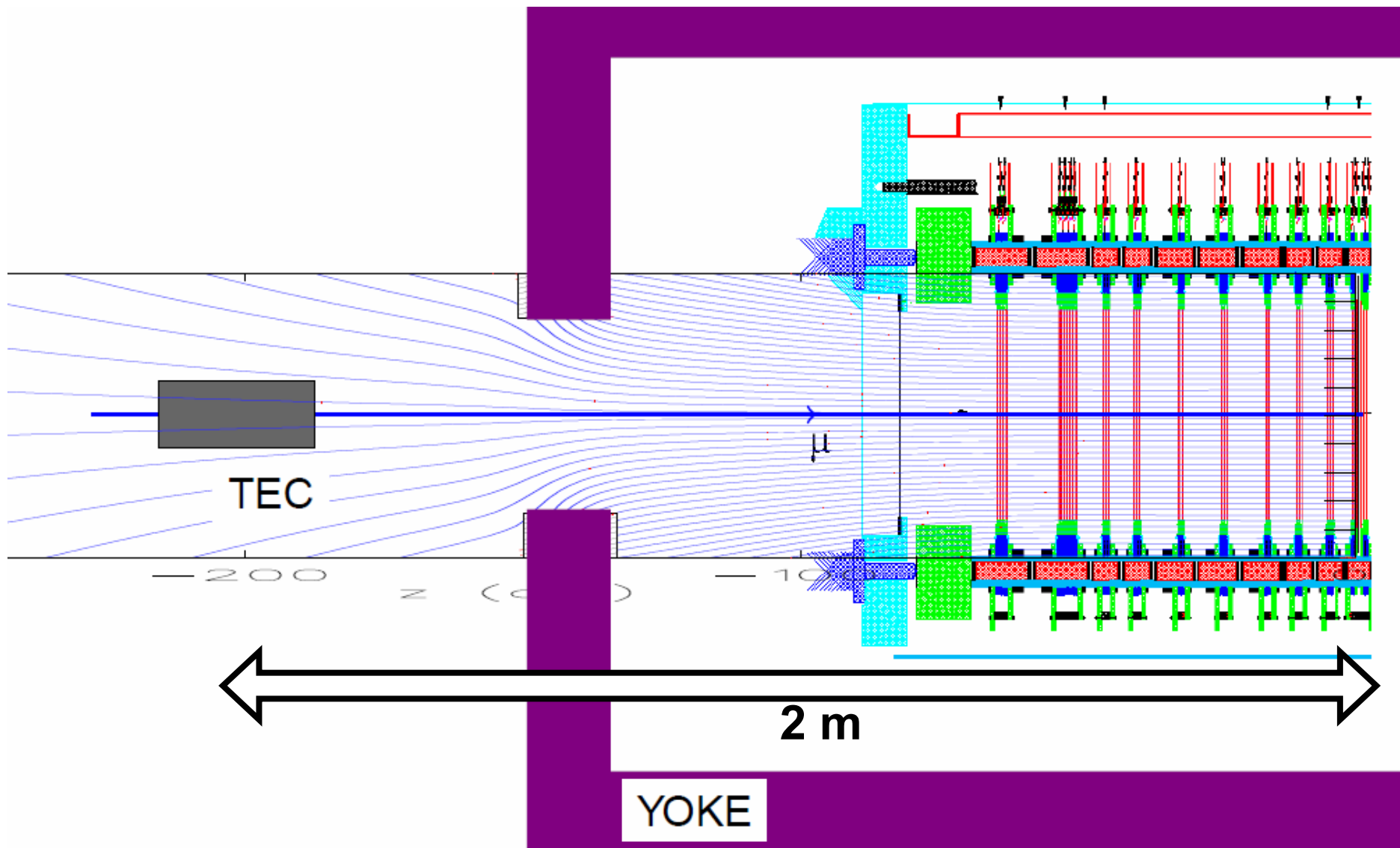

Muon beam and fringe field

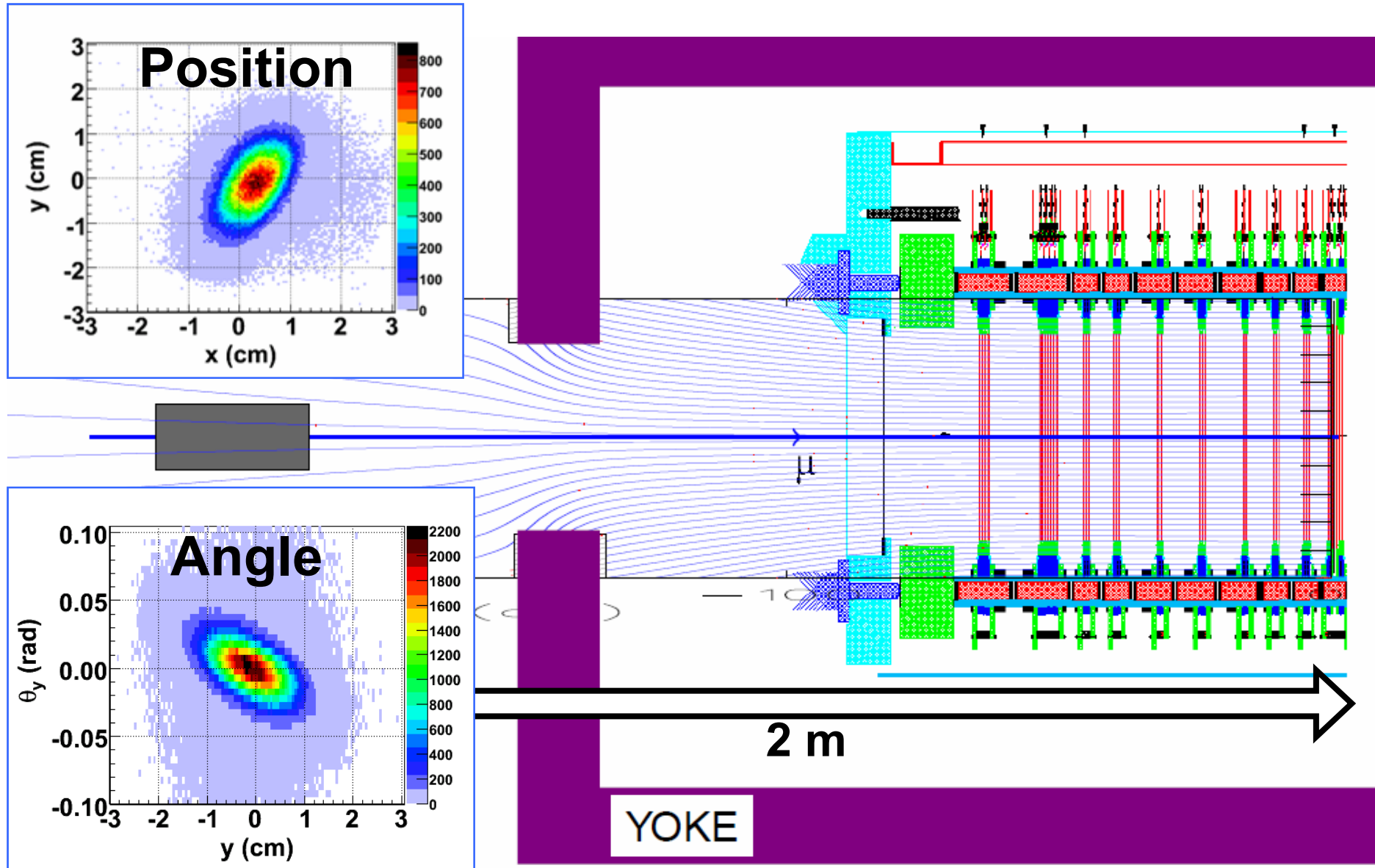

Muon beam and fringe field

Transverse magnetic field components

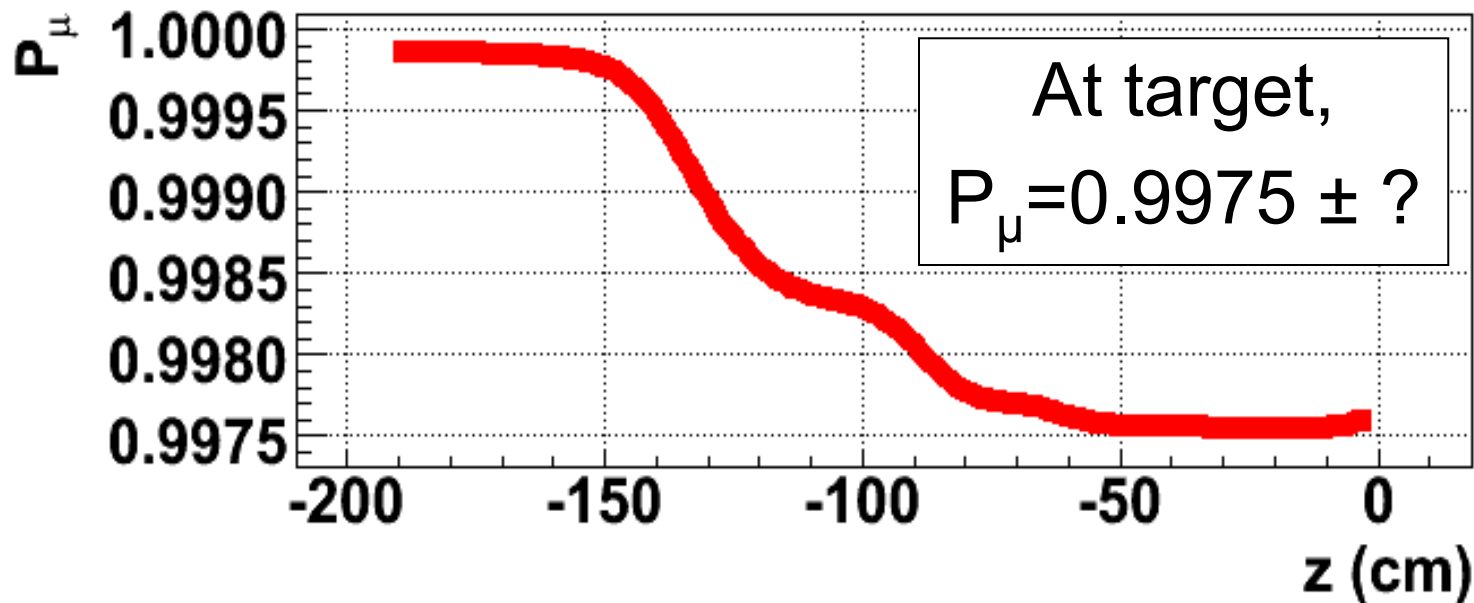
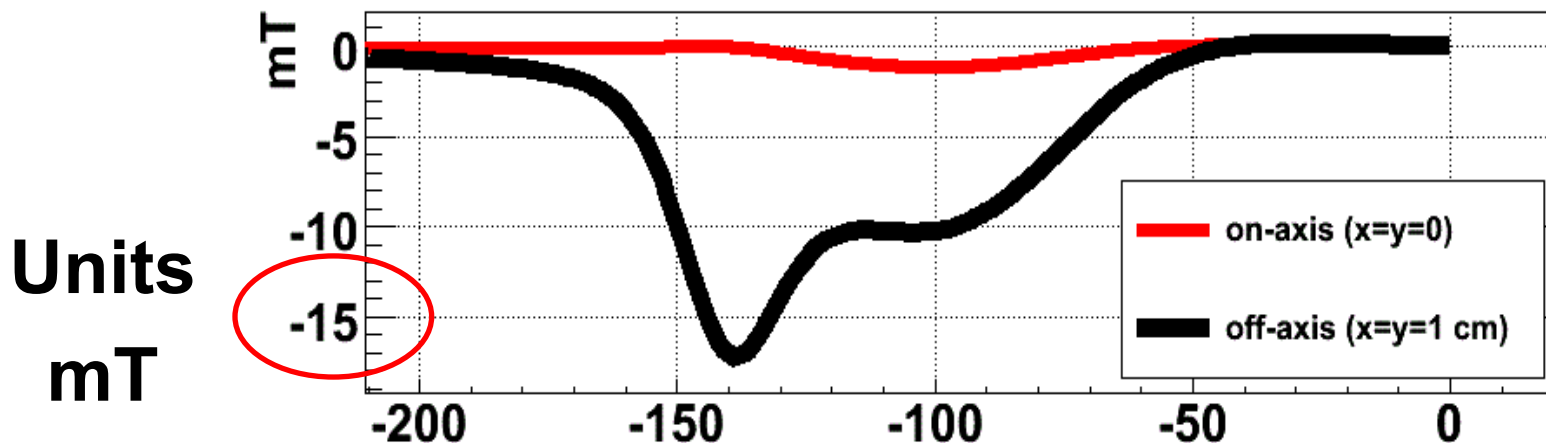

Muon beam and fringe field

How accurately do we know the beam polarisation at target entry?

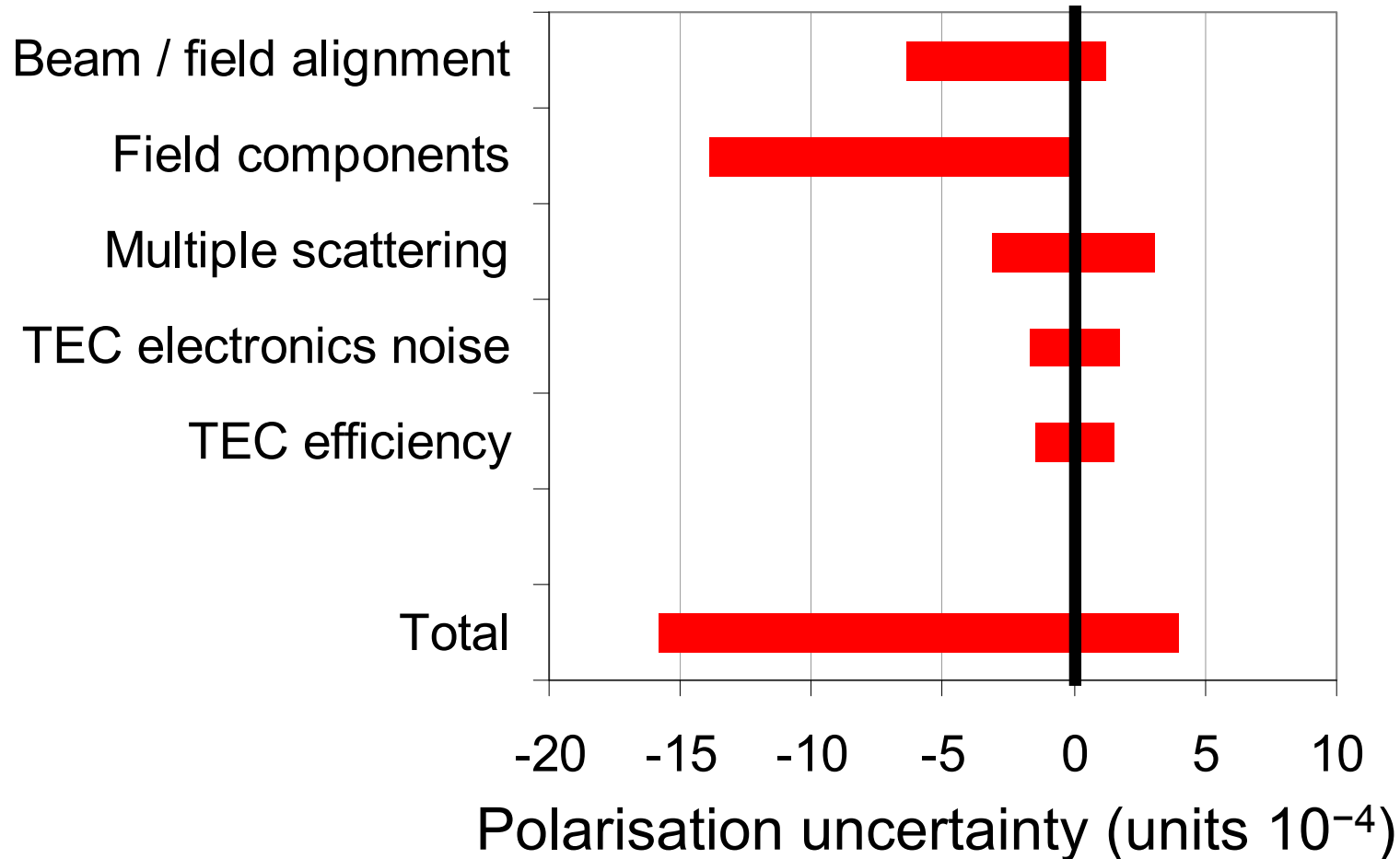

Muon beam / field alignment

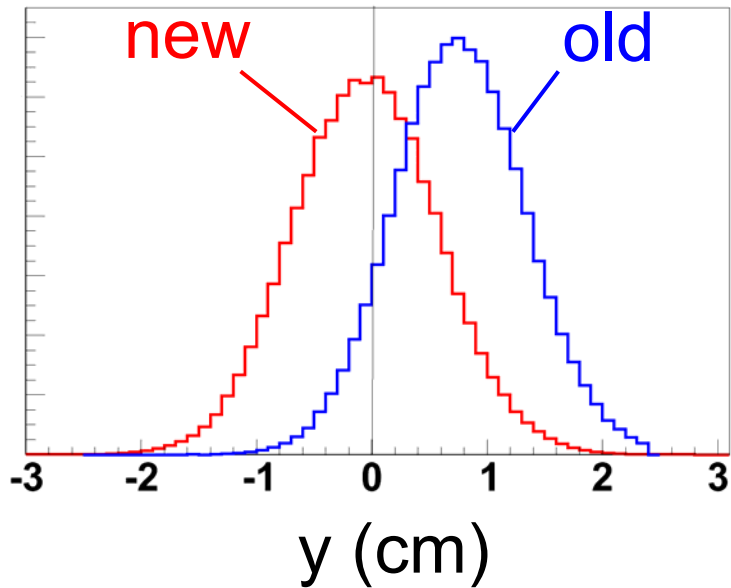

Beam steered onto symmetry axis.

P_μ now less sensitive to alignment uncertainties.

Alignment uncertainties	Position	Angle
Muon beam	± 0.2 cm	± 3 mrad
Magnetic field	± 0.1 cm	± 1 mrad

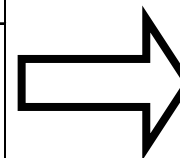

P_μ uncertain at level of

$$\pm 1.2 - 6.4 \times 10^{-4}$$

Magnetic field components

15

Indirect validation: polarisation of real beam lowered. How well does the simulation reproduce the changes?

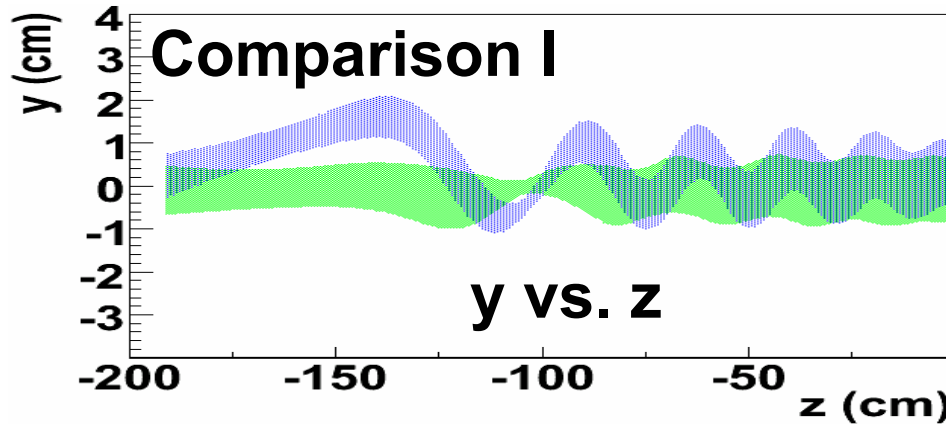

Example: angle $\theta_y \sim 28$ mrad introduced

Polarisation decrease of $(105 \pm 9) \times 10^{-4}$

Comparison II: position off axis by ~ 1 cm, angle $\theta_x \sim 10$ mrad introduced.

Comparison III: TECs-in through entire set, increasing multiple scattering upstream of fringe field.

Small transverse field components need increasing by 10% to improve data and simulation agreement.

Selecting muons in metal target

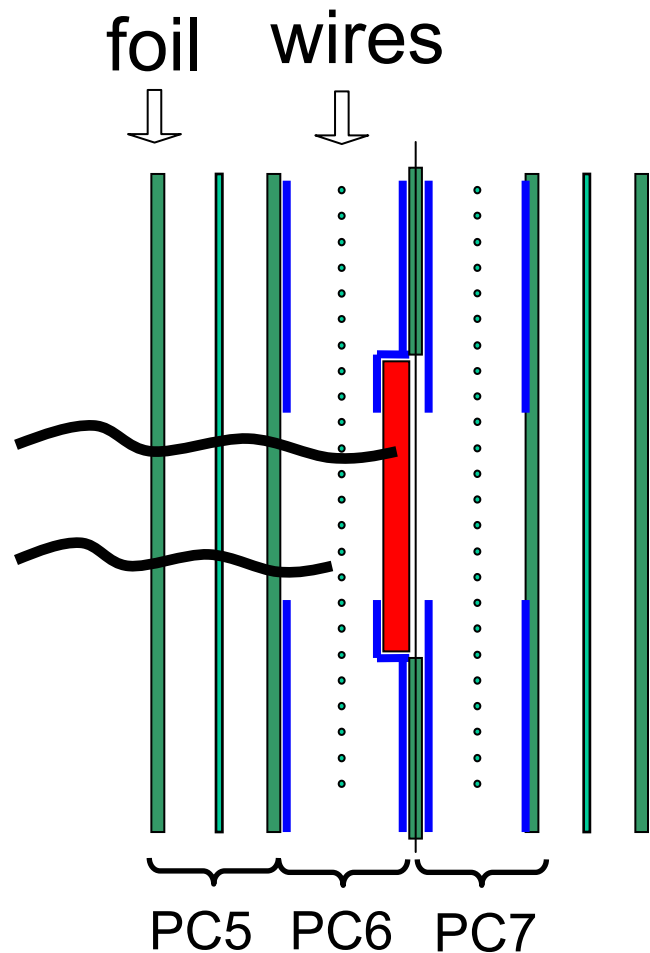

Muon last hit must be in PC6, with no signal in PC7.

(PC = proportional chamber)

Selecting muons in metal target

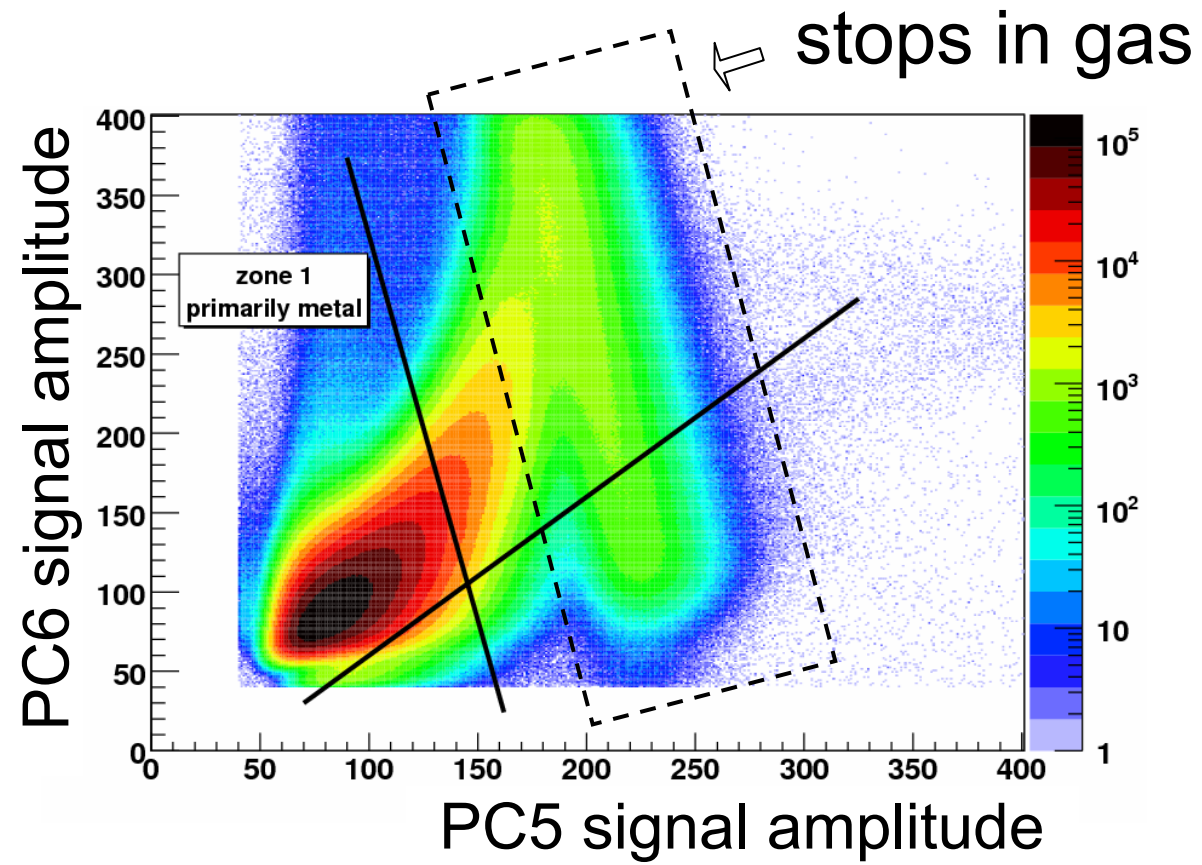
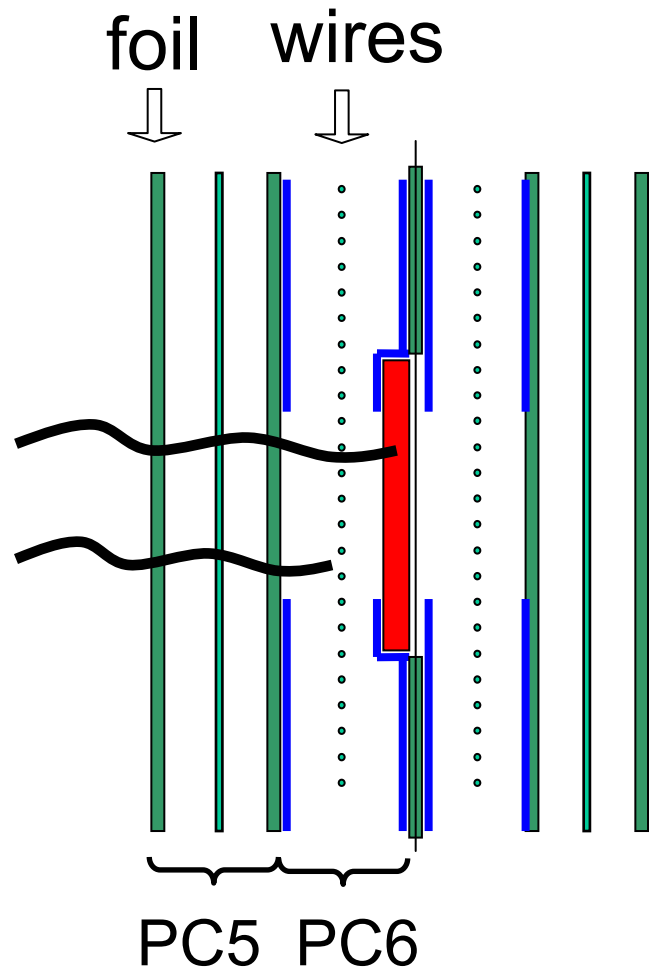

Cut placed so that $< 0.5\%$ of the gas distribution contaminates “zone 1”.

(PC = proportional chamber)

Measuring depolarisation in target

Targets are high purity (>99.999% purity) Al and Ag.

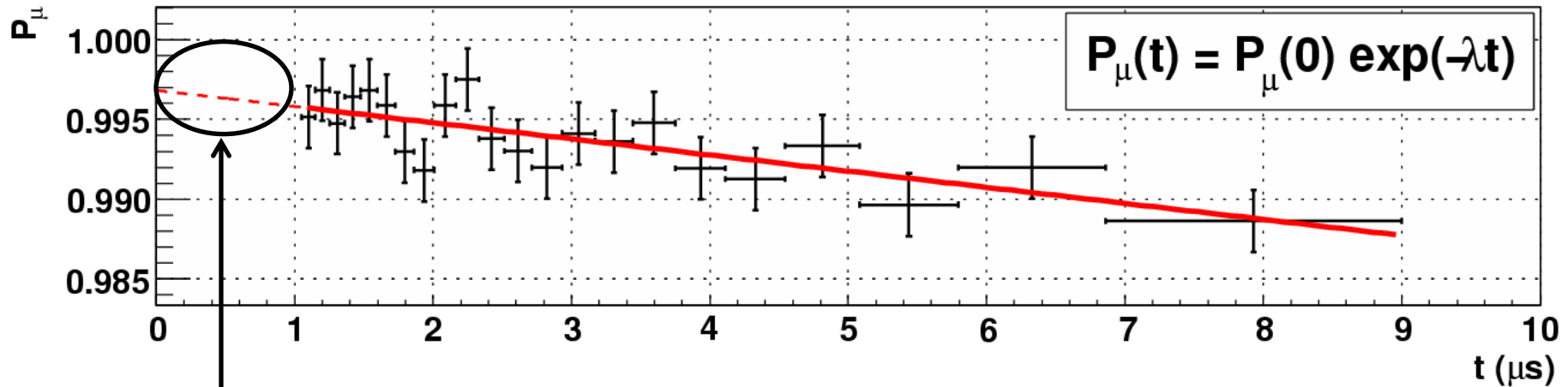

Subsidiary μ^+ SR
experiment:

no “fast depolarisation”
down to 5 ns

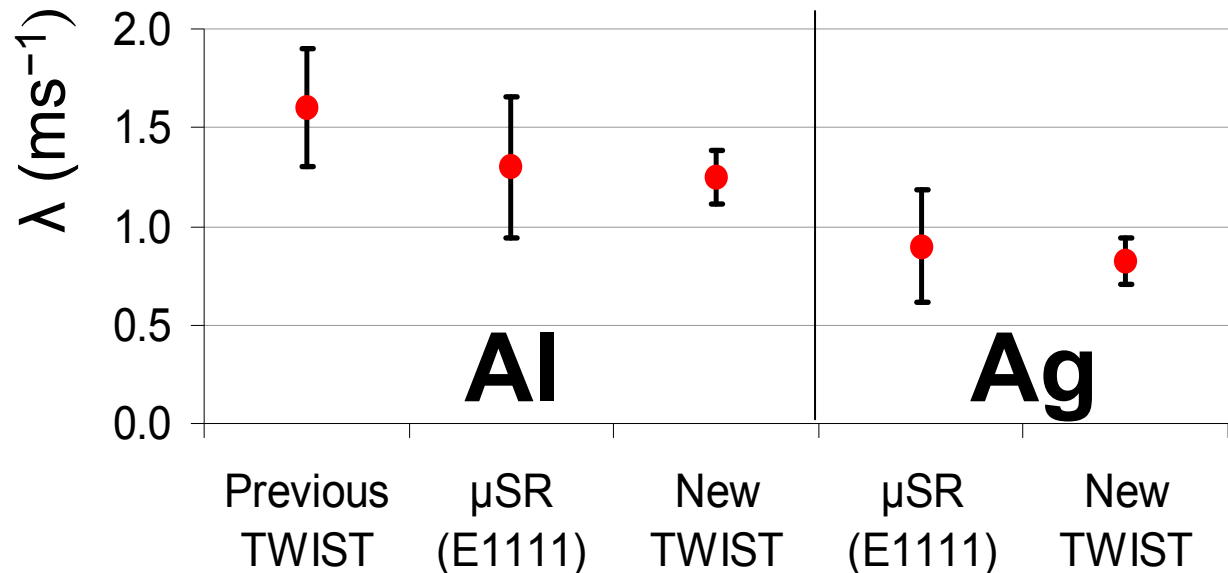

- Apparatus improvements
- Systematic uncertainties for ρ and δ
- Systematic uncertainties for $P_{\mu\xi}$
- Quality of data
- The final results

First announcement outside of TRIUMF

- Implications for the Standard Model

Set-to-set consistency: ρ and δ

(difference between data and hidden values)

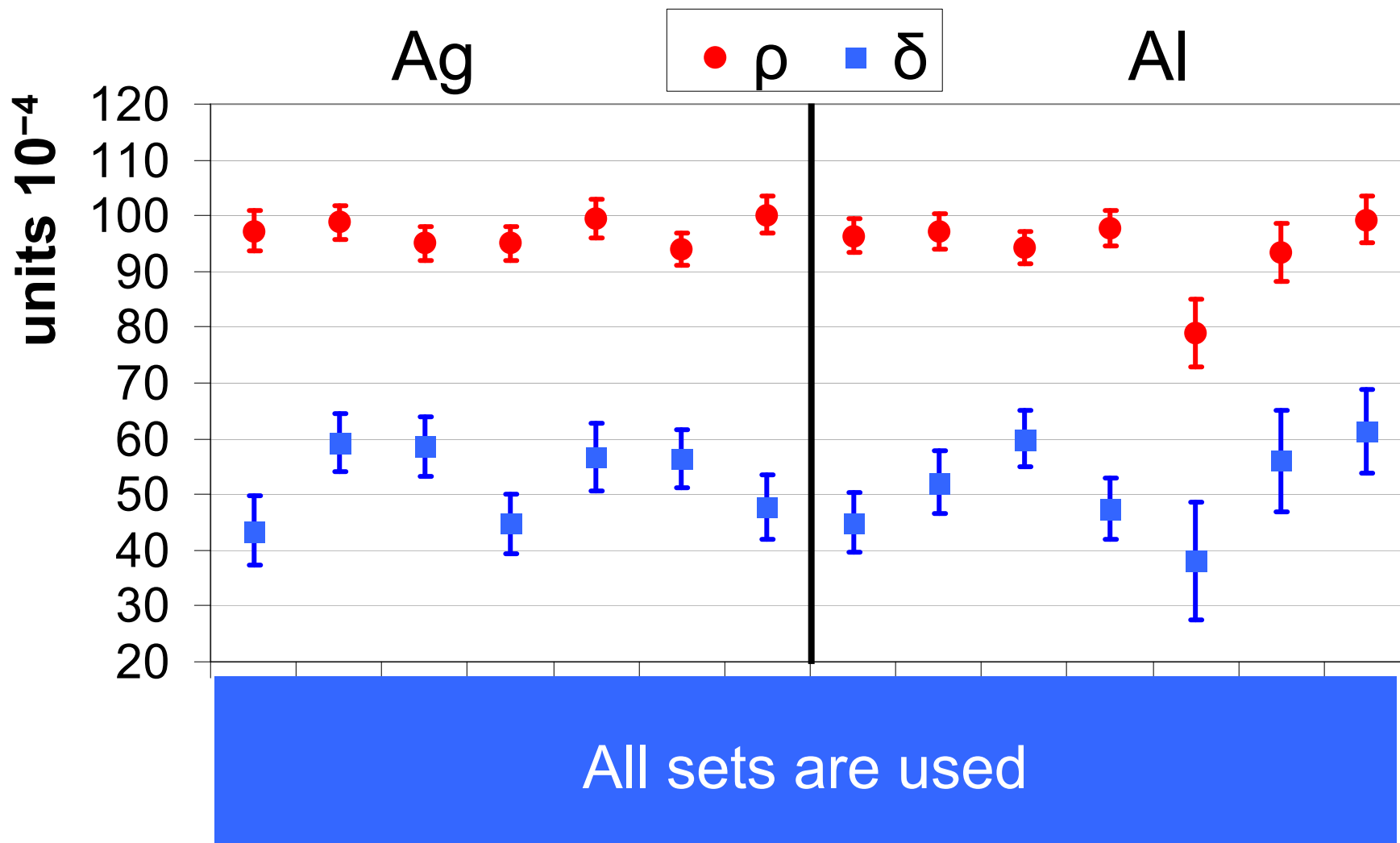

Set-to-set consistency: ρ and δ

(difference between data and hidden values)

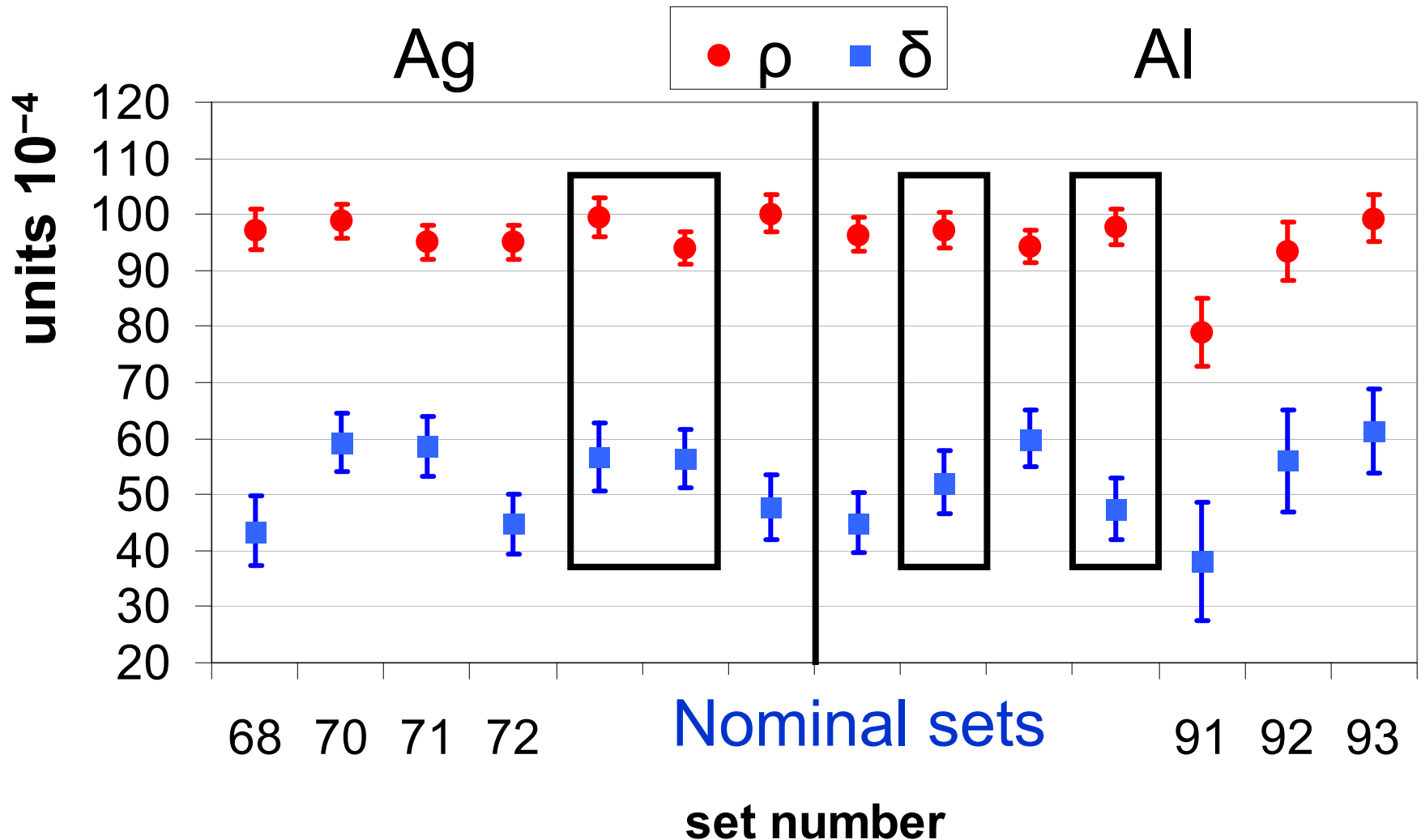

Set-to-set consistency: ρ and δ

(difference between data and hidden values)

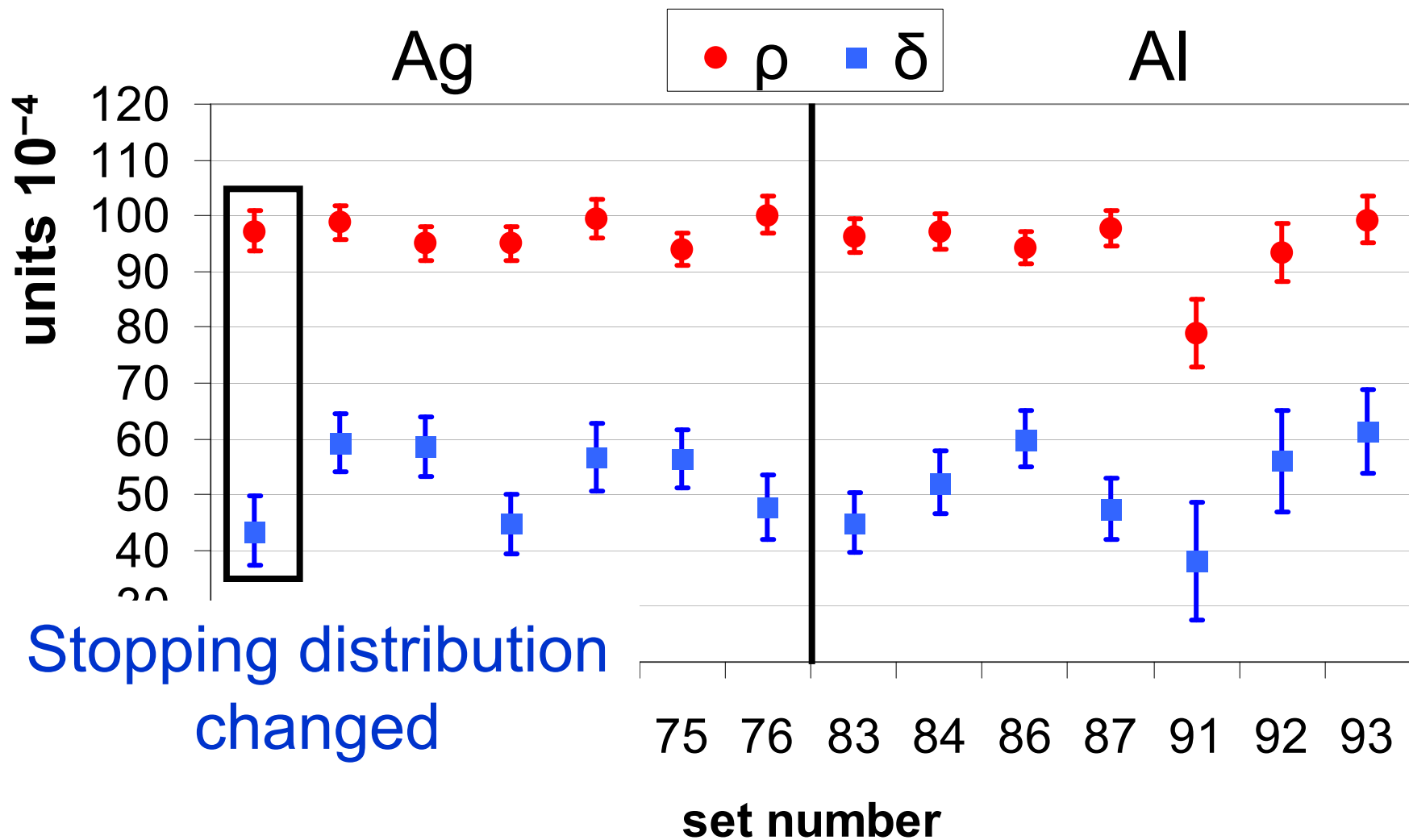

Set-to-set consistency: ρ and δ

(difference between data and hidden values)

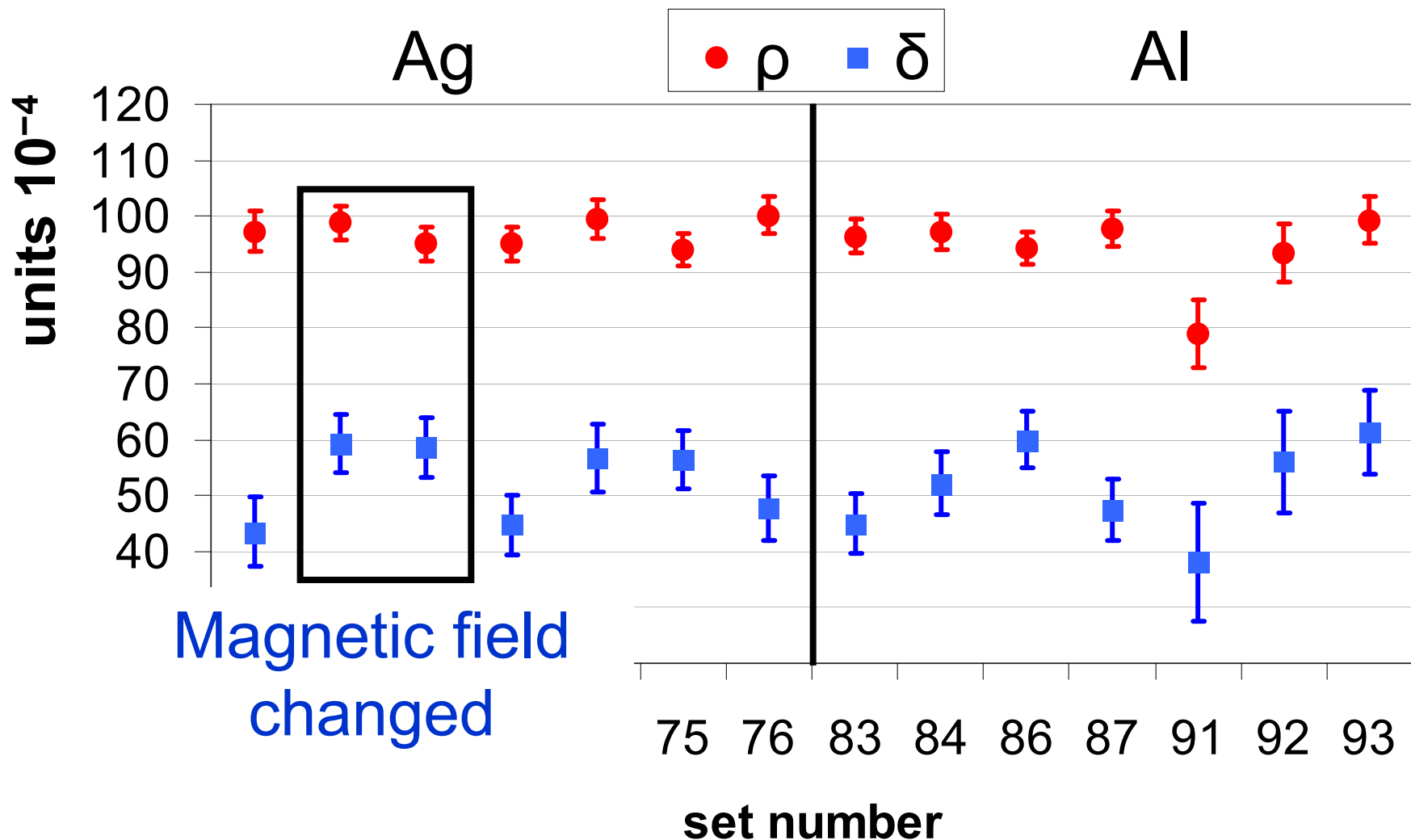

Set-to-set consistency: ρ and δ

(difference between data and hidden values)

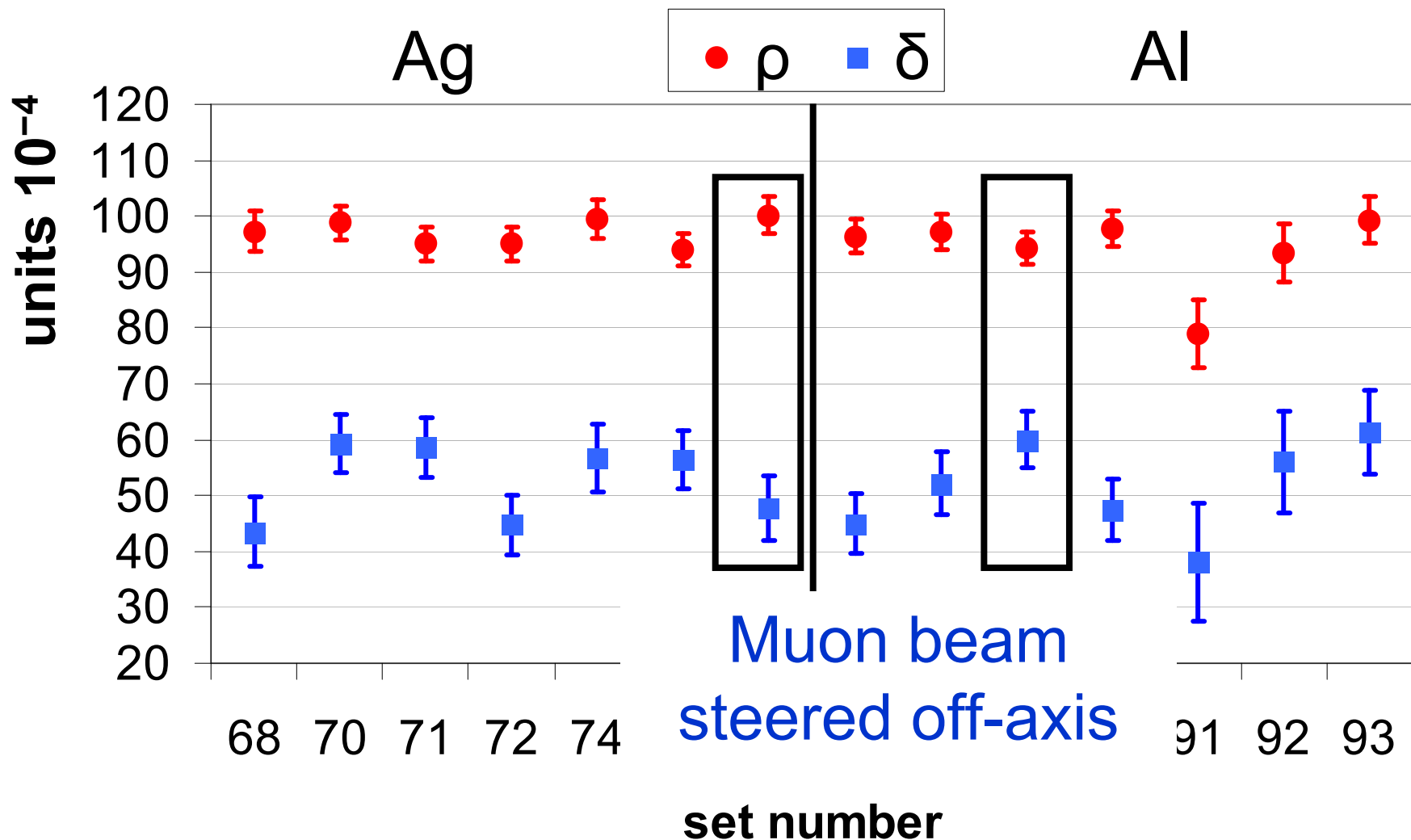

Set-to-set consistency: ρ and δ

(difference between data and hidden values)

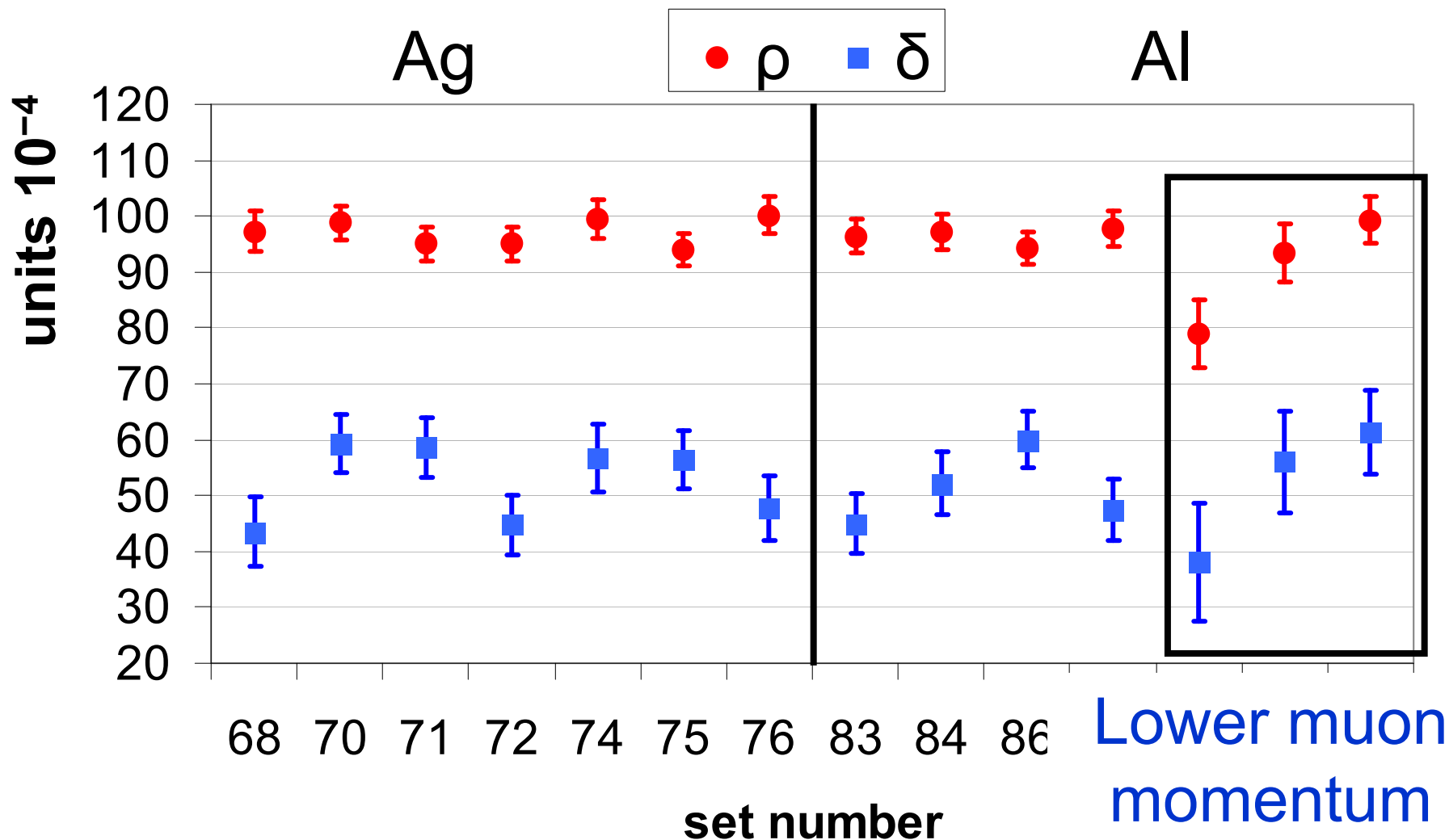

Set-to-set consistency: $P_{\mu\xi}$

(difference between data and hidden values)

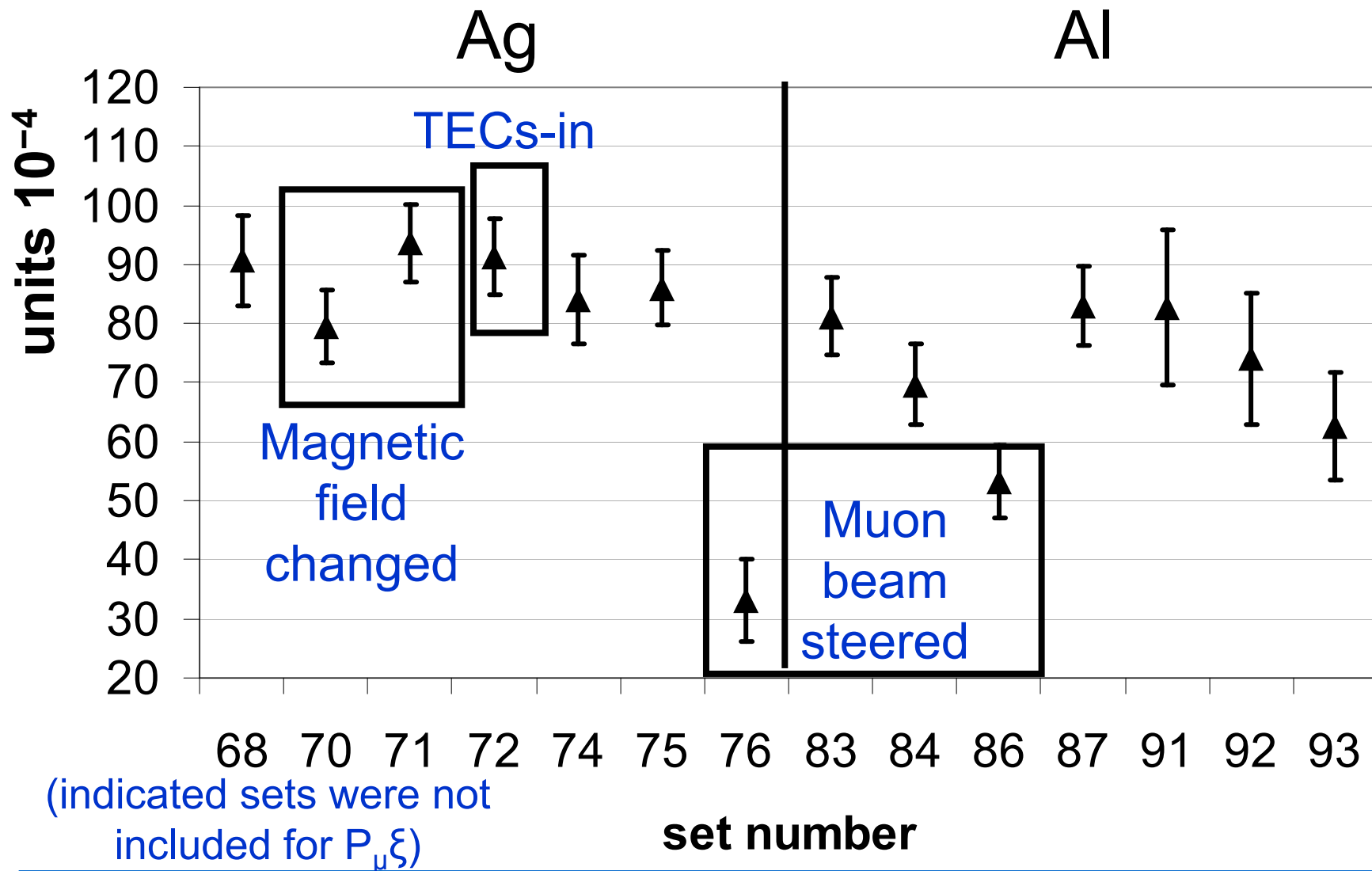

Spectrum fit quality

Normalised residuals for nominal set (s87)

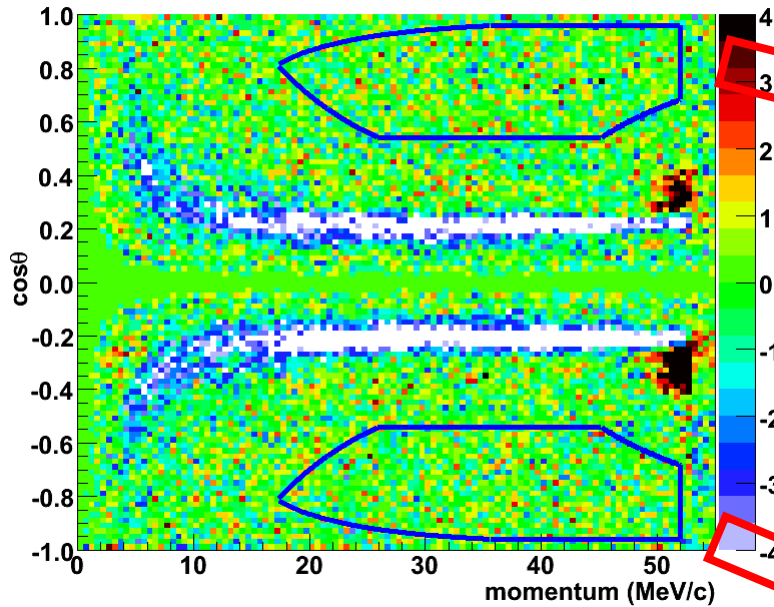

Residuals in fiducial only (all sets)

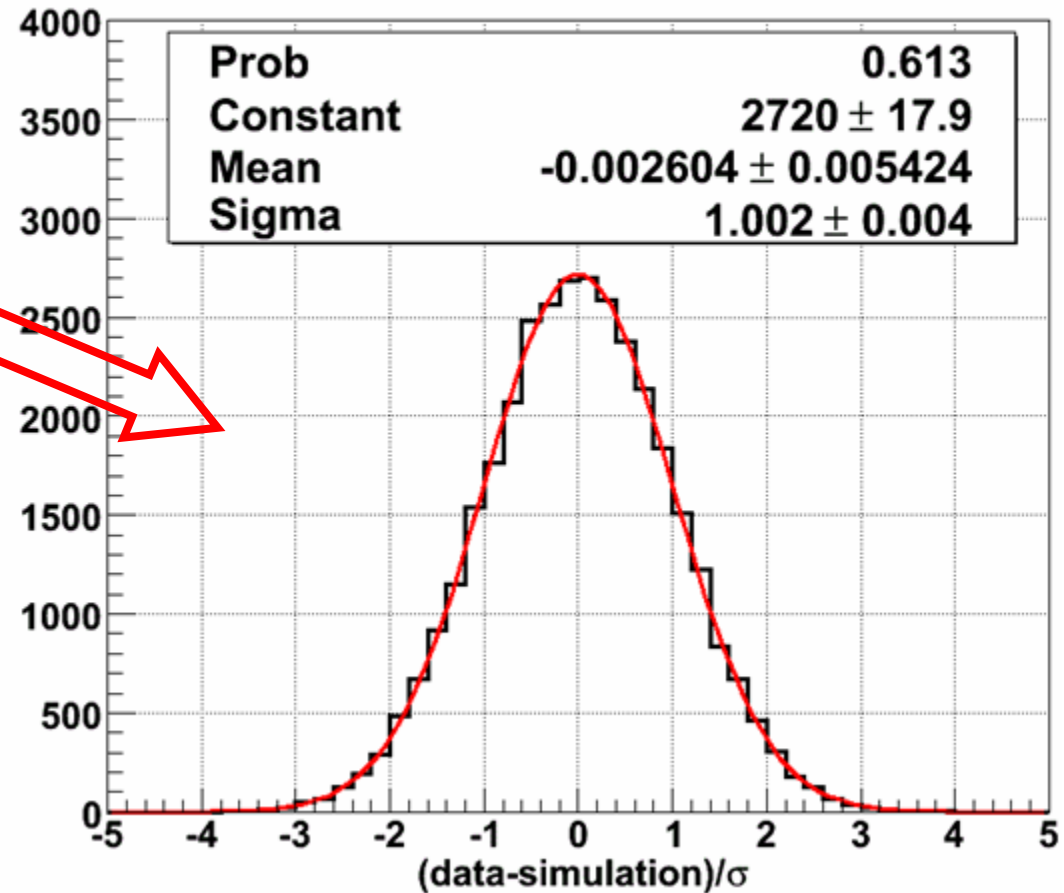

Excellent fit
quality over
kinematic fiducial

Collaboration agreed on:

- Data sets to include.
- Systematic uncertainties and corrections.
- Level of required consistency with previous results.

- Do we combine new results with intermediate TWIST measurements? (*new results supersede*)
- Course of action if results are inconsistent with the Standard Model. (*we publish!*)

Results revealed (29 Jan 2010)

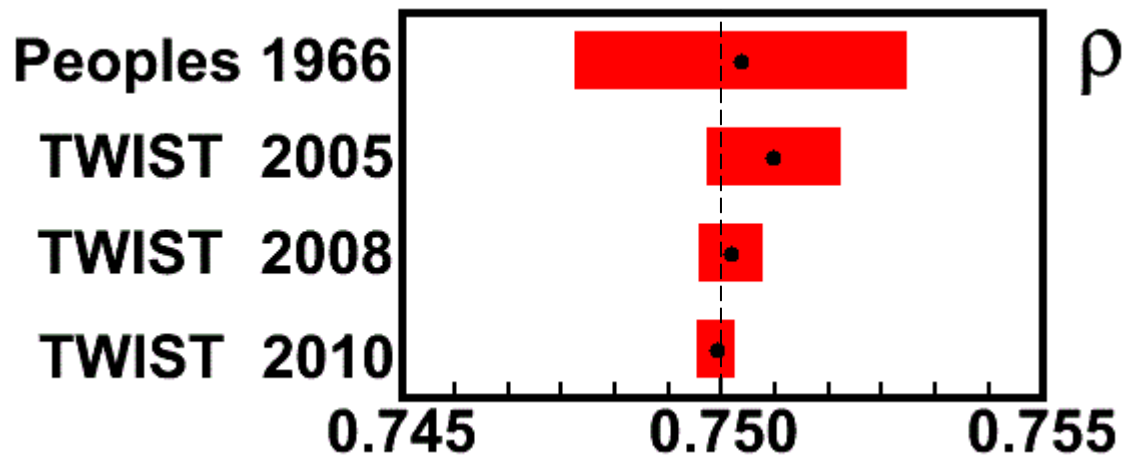

$$\rho = 0.74991 \pm 0.00009 \text{ (stat)} \pm 0.00028 \text{ (syst)}$$

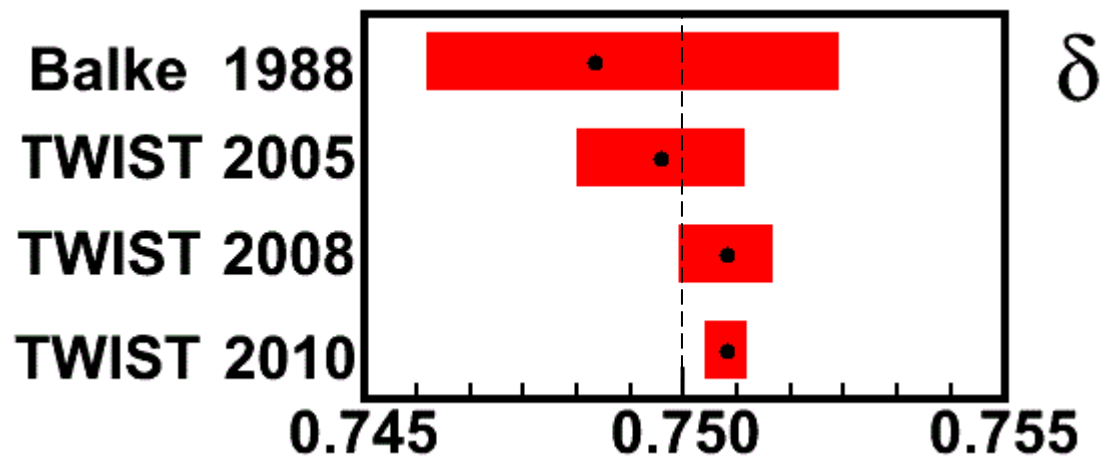

$$\delta = 0.75072 \pm 0.00016 \text{ (stat)} \pm 0.00029 \text{ (syst)}$$

Results revealed (29 Jan 2010)

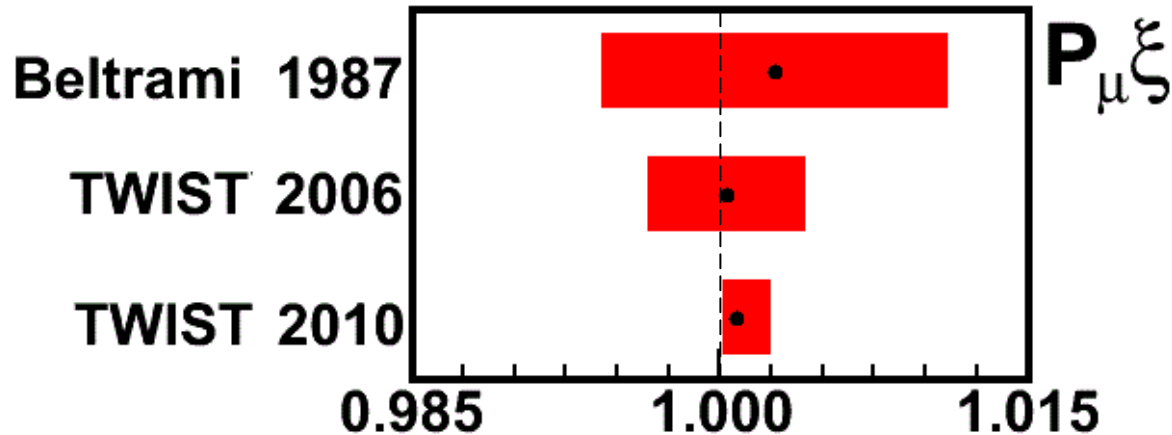

$$P_{\mu\xi} = 1.00084 \pm 0.00035 \text{ (stat)} + 0.00165 \text{ (syst)} - 0.00063 \text{ (syst)}$$

Pre-TWIST: $0.9975 \leq P_{\mu}\delta/\rho$ (90% C.L.)

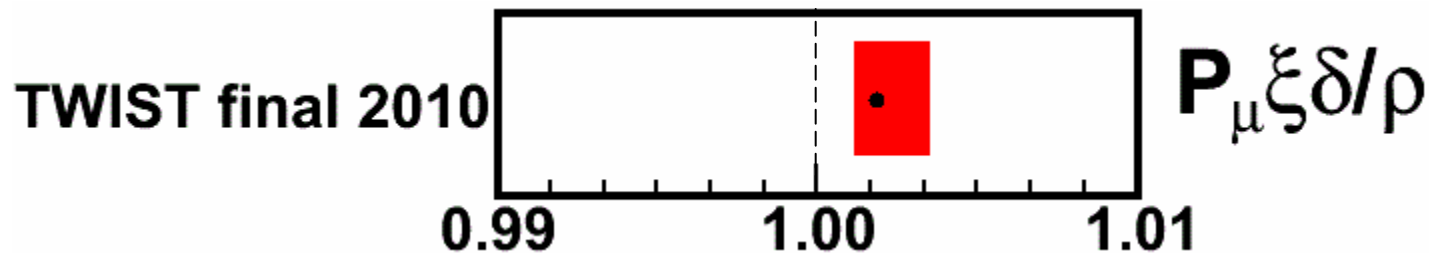

$$P_{\mu\xi}\delta/\rho = 1.00192 + 0.00167 - 0.00066$$

2.9 σ from SM, under investigation

Left-right symmetric models

Phys. Rev. D 34, 3449 - 3456 (1986)

- Models add a right-handed current (V+A) to the weak interaction.
- Right-handed W-boson introduced at higher energies.
- Mass of $W_R >$ Mass of W_L .

Weak interaction eigenstates (W_L, W_R) in terms of mass eigenstates (W_1, W_2) and mixing angle (ζ):

$$\begin{aligned} W_L &= W_1 \cos \zeta + W_2 \sin \zeta \\ W_R &= e^{i\omega} (-W_1 \sin \zeta + W_2 \cos \zeta) \end{aligned}$$

Muon polarisation and decay parameters ξ and ρ are sensitive to m_2 (the new boson's mass) and ζ (the mixing angle).

Left-right symmetric models

Phys. Rev. D 34, 3449 - 3456 (1986)

90% C.L. exclusion

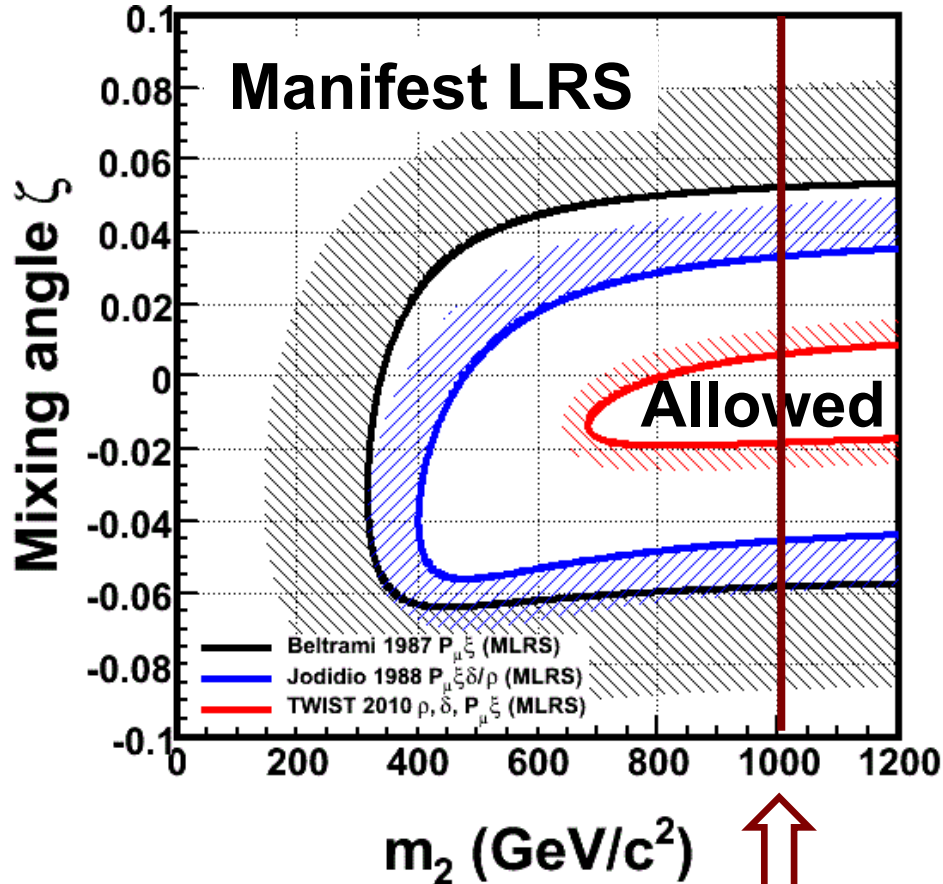

90% C.L. exclusion

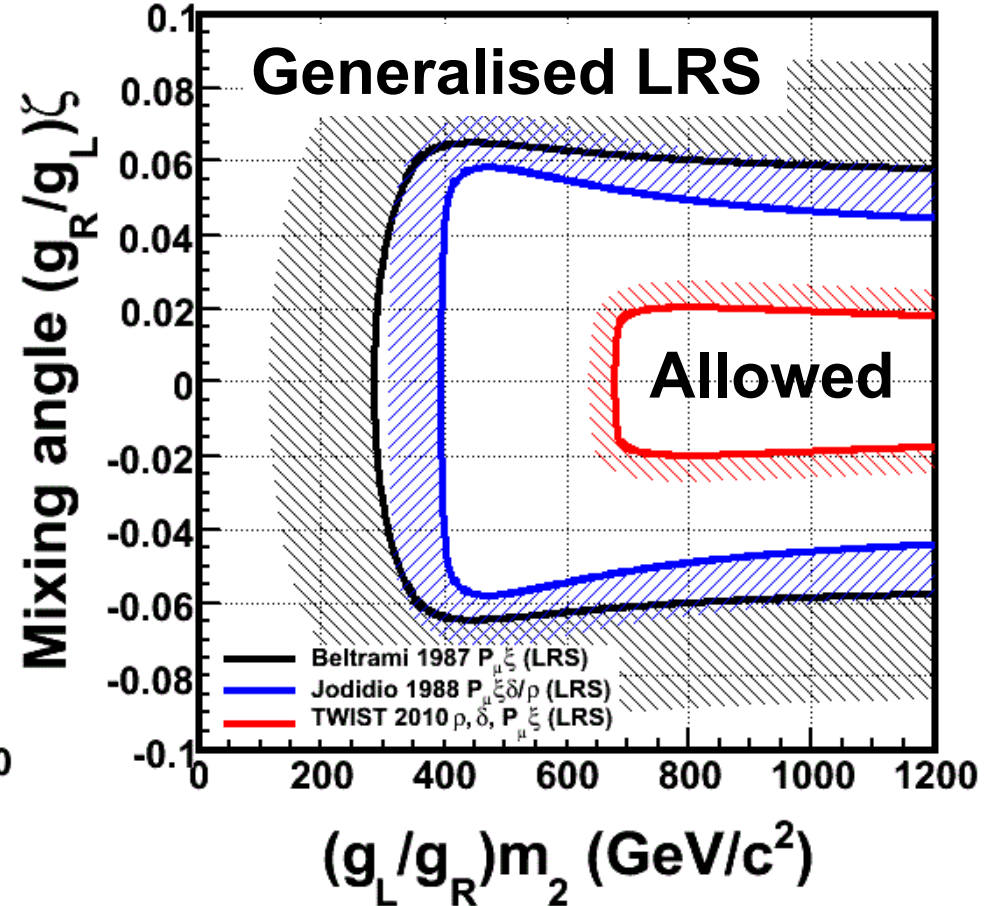

D0 direct search

Phys. Rev. Lett. 100, 031804 (2008)

Global analysis of muon decay data 26

Method described in Phys. Rev. D, 72:073002 (2005)

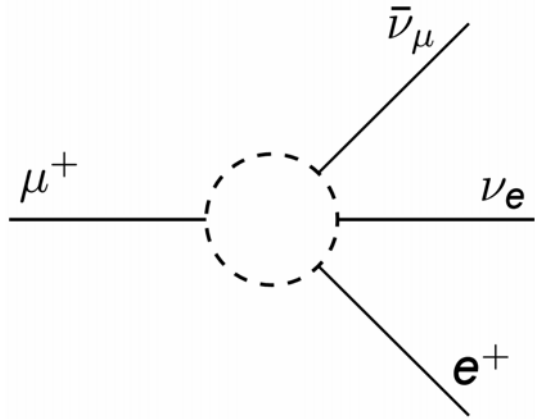

General 4-fermion interaction:

$$M = 4 \frac{G_F}{\sqrt{2}} \sum_{\substack{\gamma = S, V, T \\ \epsilon, \mu = R, L}} g_{\epsilon\mu}^{\gamma} \langle \bar{e}_{\epsilon} | \Gamma^{\gamma} | \nu_e \rangle \langle \bar{\nu}_{\mu} | \Gamma_{\gamma} | \mu_{\mu} \rangle$$

Standard Model (“V-A”): $g_{LL}^V = 1$
(all others zero)

Global analysis determines weak coupling constants using:

- TWIST results: ρ , δ , $P_{\mu\xi}$
- Polarisation of e^+ (longitudinal and transverse)
- Radiative muon decay

Global analysis of muon decay data 27

- New limit on right-handed muon couplings:

Pre-TWIST:	$Q_R^\mu < 5.1 \times 10^{-3}$	(90% C.L.)
New result:	$Q_R^\mu < 5.8 \times 10^{-4}$	(90% C.L.)

- Uncertainty for η reduced:

2005 global analysis:	$\eta = -0.0036 \pm 0.0069$
New result:	$\eta = -0.0033 \pm 0.0046$

- Improved uncertainties for other coupling constants:

Preliminary	Coupling	Pre-TWIST	New
	$ g_{RR}^S $	< 0.066	< 0.031
	$ g_{RR}^V $	< 0.033	< 0.015
	$ g_{LR}^S $	< 0.125	< 0.041
	$ g_{LR}^V $	< 0.060	< 0.018
	$ g_{LR}^T $	< 0.036	< 0.012

- Systematic uncertainties in muon decay parameter measurements were substantially reduced in **TWIST**.
- Total uncertainties were reduced by factors of **8.7**, **11.6**, and **7.0** for ρ , δ and $P_{\mu\xi}$ respectively, roughly achieving the goals of the experiment.
- Differences with Standard Model predictions are respectively **-0.3σ** , **$+2.2 \sigma$** , and **$+1.2 \sigma$** .
- We cannot yet explain the more significant deviation of $P_{\mu\xi} \delta/\rho$ above the limit of 1.0.

The TWIST collaboration (<http://twist.triumf.ca>)

TRIUMF

Ryan Bayes*†
Yuri Davydov
Wayne Faszler
Makoto Fujiwara
David Gill
Alexander Grossheim
Peter Gumplinger
Anthony Hillairet*†
Robert Henderson

Jingliang Hu
Glen Marshall
Dick Mischke
Konstantin Olchanski
Art Olin†
Robert Openshaw
Jean-Michel Poutissou
Renée Poutissou
Grant Sheffer
Bill Shin‡‡

Alberta

Andrei Gaponenko*
Robert MacDonald*

British Columbia

James Bueno*
Mike Hasinoff

Texas A&M

Carl Gagliardi
Bob Tribble

Regina

Ted Mathie
Roman Tacik

Kurchatov Institute

Vladimir Selivanov

Montréal

Pierre Depommier

Valparaiso

Don Koetke
Shirvel Stanislaus

* = graduate student

† = also UVIC

‡‡ = also Saskatchewan



Supported by NSERC, the National Research Council of Canada, the Russian Ministry of Science, and the US department of energy. Computing resources provided by WestGrid.

James Bueno, WNPPC 2010, Banff, Alberta

Backup slides

Magnetic field components

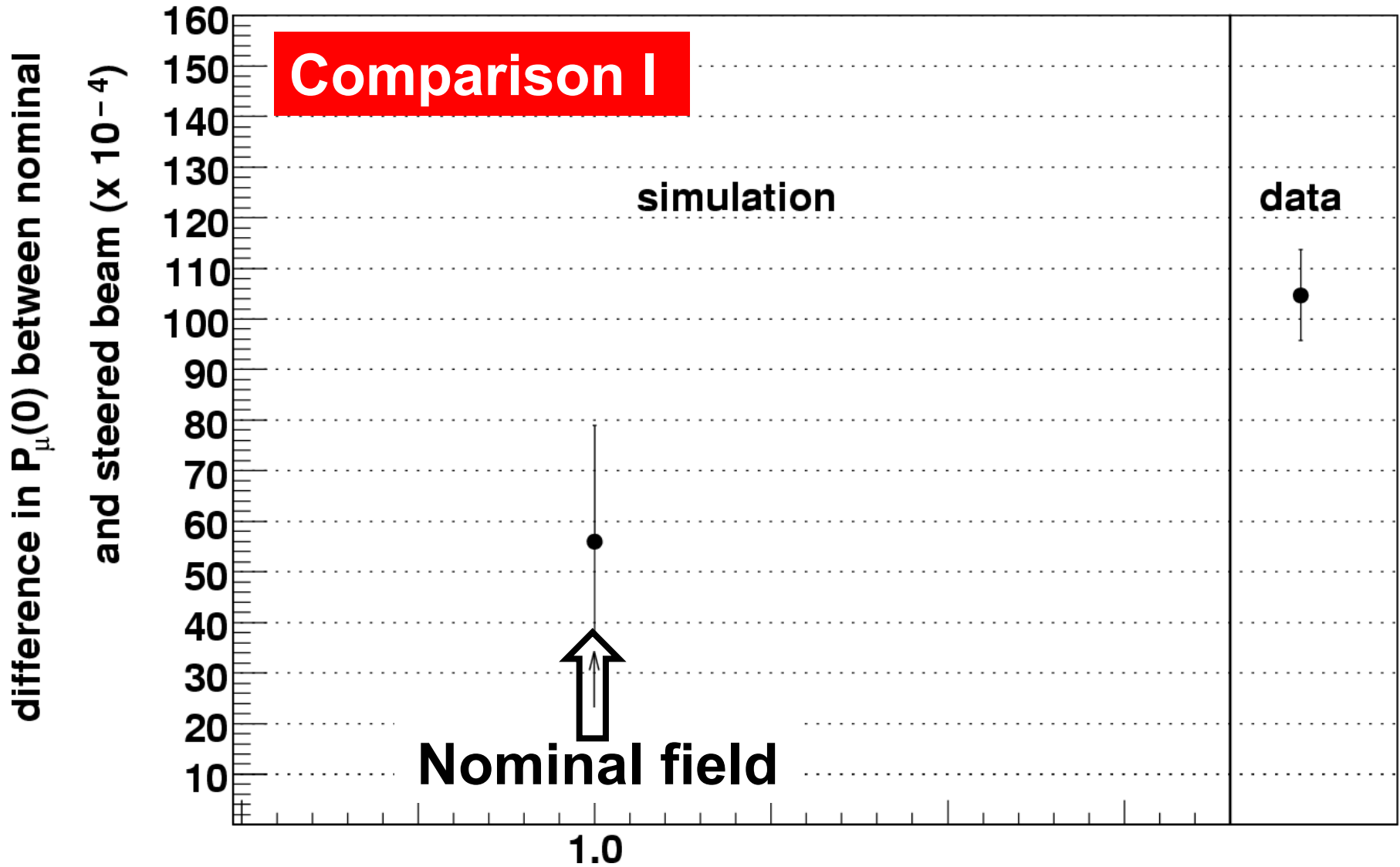

Magnetic field components

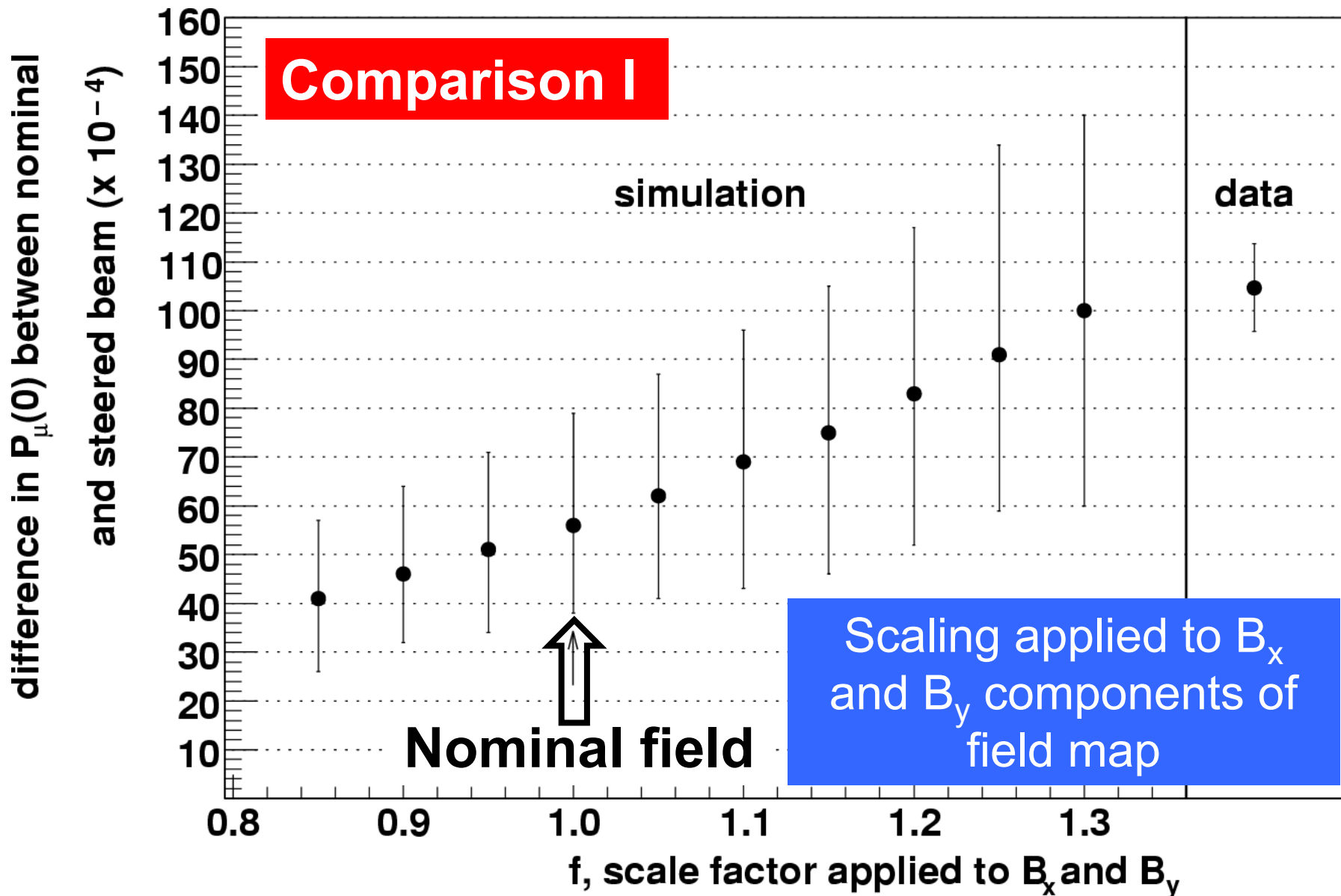

Magnetic field components

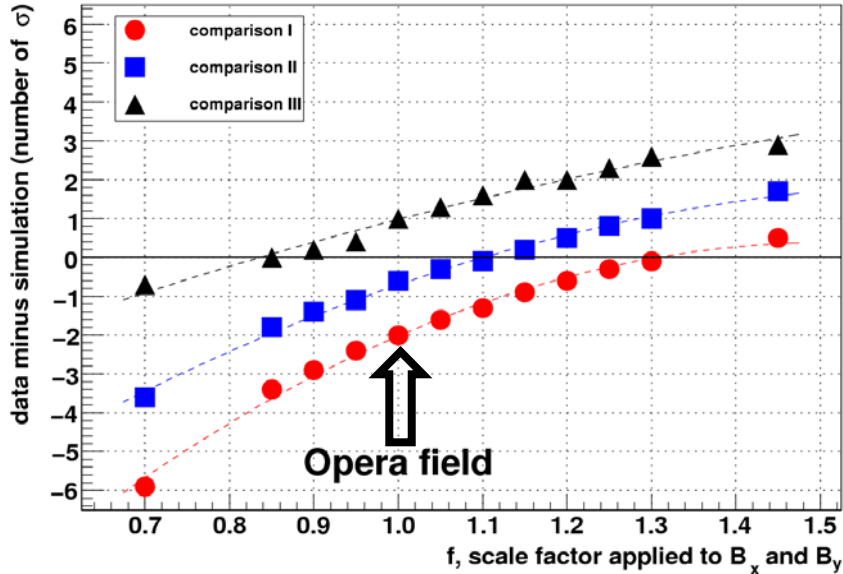

Small transverse magnetic field components are scaled.

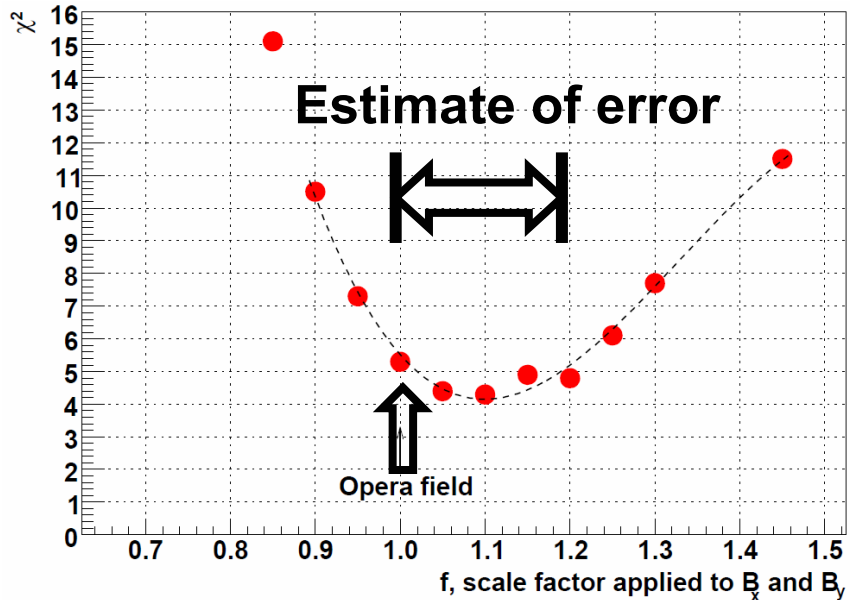

Data and simulation agree best when components are increased by 10%.

Coupling constants and decay parameters

The muon decay parameters are bilinear combinations of the coupling constants:

$$\rho = \frac{3}{4} - \frac{3}{4} [|g_{RL}^V|^2 + |g_{LR}^V|^2 + 2 |g_{RL}^T|^2 + 2 |g_{LR}^T|^2 + \text{Re}(g_{RL}^S g_{RL}^{T*} + g_{LR}^S g_{LR}^{T*})]$$

$$\eta = \frac{1}{2} \text{Re}[g_{RR}^V g_{LL}^{S*} + g_{LL}^V g_{RR}^{S*} + g_{RL}^V (g_{LR}^{S*} + 6g_{LR}^{T*}) + g_{LR}^V (g_{RL}^{S*} + 6g_{RL}^{T*})]$$

$$\xi = 1 - \frac{1}{2} |g_{LR}^S|^2 - \frac{1}{2} |g_{RR}^S|^2 - 4 |g_{RL}^V|^2 + 2 |g_{LR}^V|^2 - 2 |g_{RR}^V|^2 + 2 |g_{LR}^T|^2 - 8 |g_{RL}^T|^2 + 4 \text{Re}(g_{LR}^S g_{LR}^{T*} - g_{RL}^S g_{RL}^{T*})$$

$$\xi\delta = \frac{3}{4} - \frac{3}{8} |g_{RR}^S|^2 - \frac{3}{8} |g_{LR}^S|^2 - \frac{3}{2} |g_{RR}^V|^2 - \frac{3}{4} |g_{RL}^V|^2 - \frac{3}{4} |g_{LR}^V|^2 - \frac{3}{2} |g_{RL}^T|^2 - 3 |g_{LR}^T|^2 + \frac{3}{4} \text{Re}(g_{LR}^S g_{LR}^{T*} - g_{RL}^S g_{RL}^{T*})$$

Summary of improvements

	Statistical uncertainty ($\times 10^{-4}$)	Systematic uncertainty ($\times 10^{-4}$)	Improvement over pre-TWIST
ρ	± 0.9	± 2.8	factor 8.7
δ	± 1.6	± 2.9	factor 11.6
$P_{\mu\xi}$	± 3.5	+ 16.5 - 6.3	factor 7.0

Decay spectrum

When e^+ polarization not detected, spectrum is described by four muon decay parameters (bilinear combinations of $g_{\varepsilon\mu}^\gamma$'s)

$$\frac{d^2\Gamma}{dx d\cos\theta} = \frac{1}{4} m_\mu W_{\mu e}^4 G_F^2 \sqrt{x^2 - x_0^2} \cdot$$

$$\{ \mathcal{F}_{IS}(x, \rho, \eta) + \mathcal{P}_\mu \cos\theta \cdot \mathcal{F}_{AS}(x, \xi, \delta) \} + \boxed{R.C.}$$

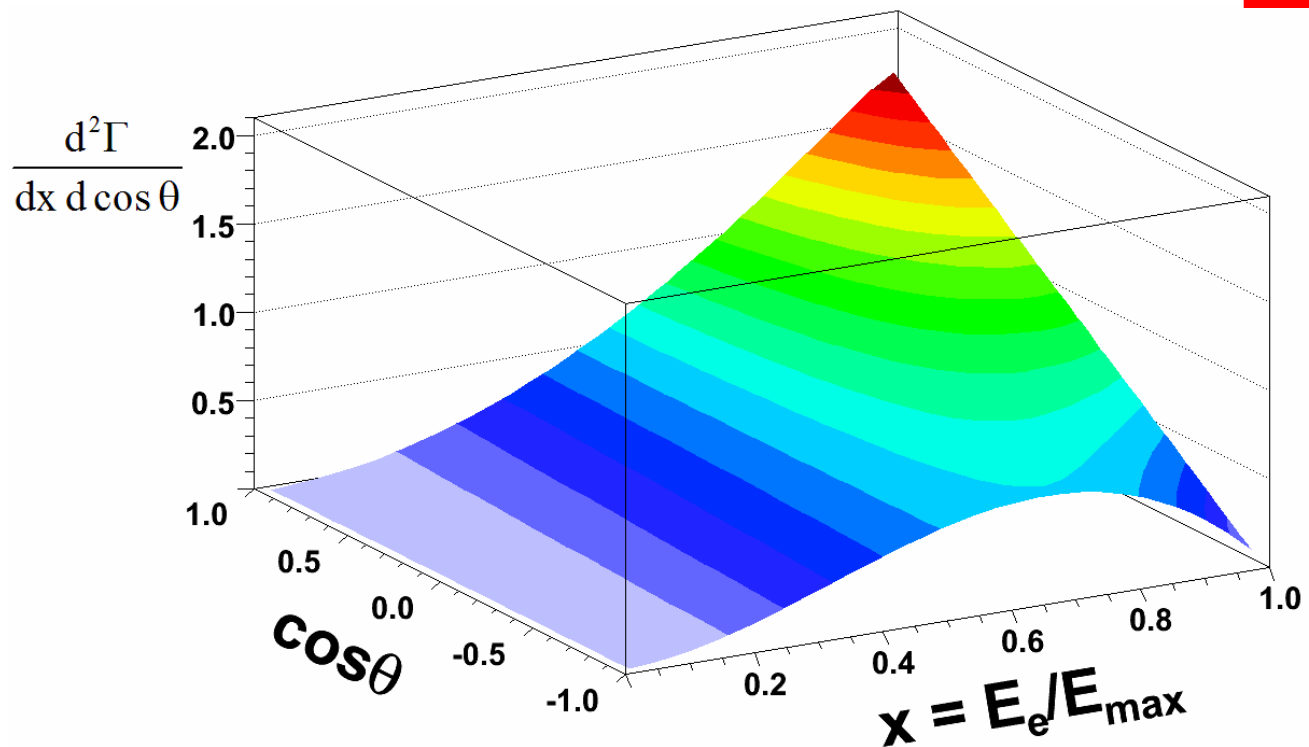
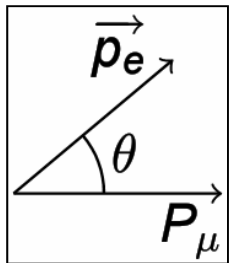

Blind analysis

- Data compared to GEANT3 simulation with hidden decay parameters.

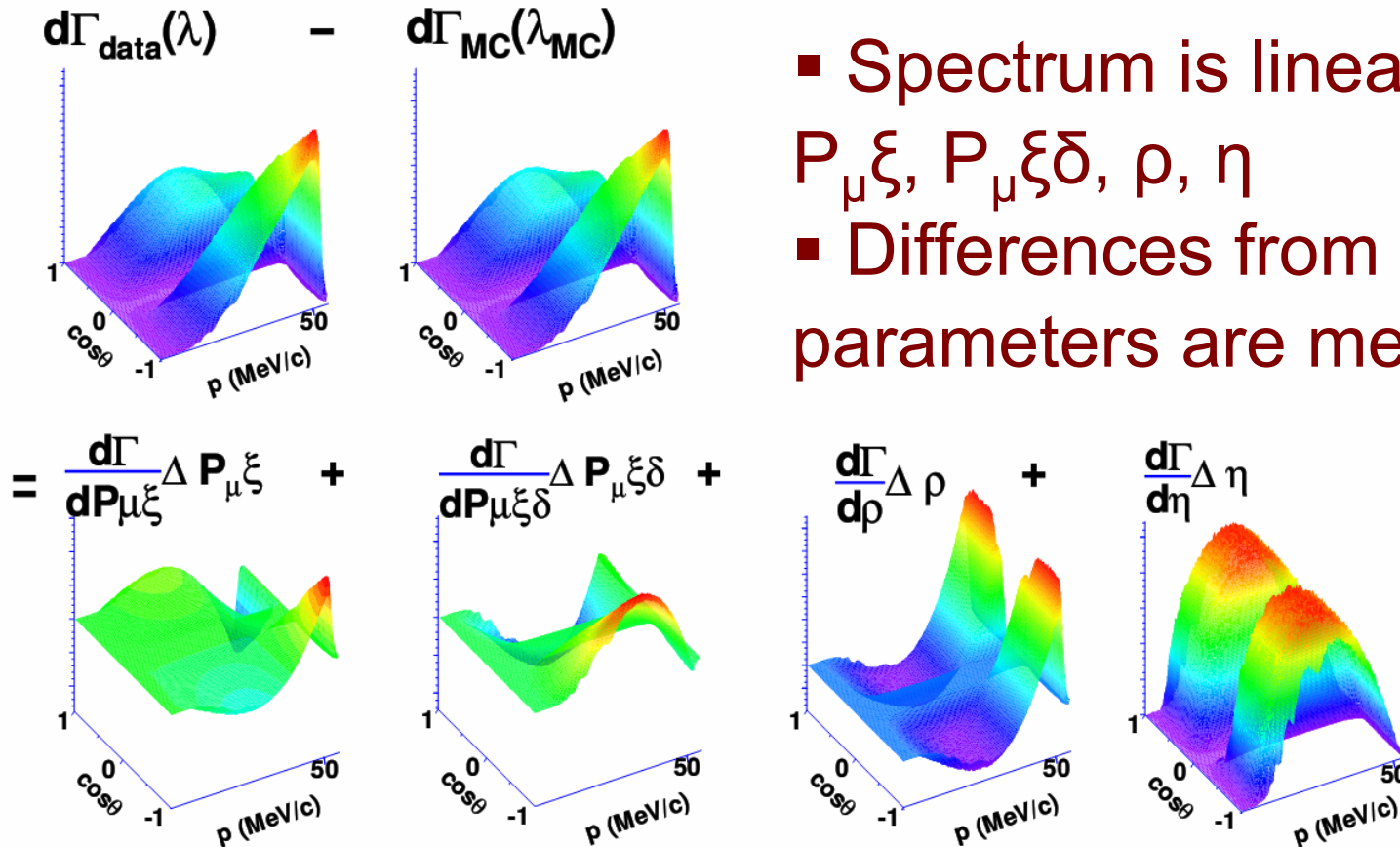

- Spectrum is linear in $P_{\mu\xi}, P_{\mu\xi\delta}, \rho, \eta$
- Differences from hidden parameters are measured.

- Hidden parameters are revealed after systematic uncertainties evaluated.

Hidden value tolerances



data minus simulation

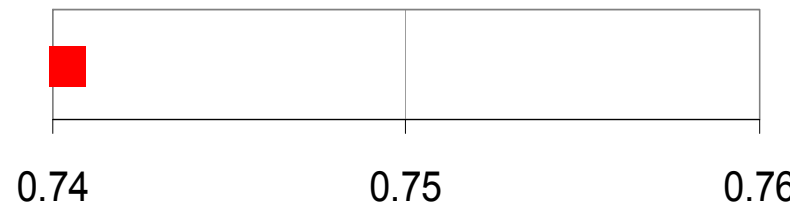

hidden value in simulation

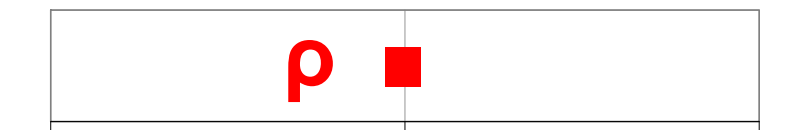

result (data)

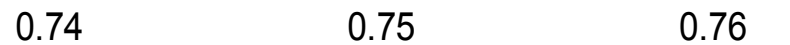
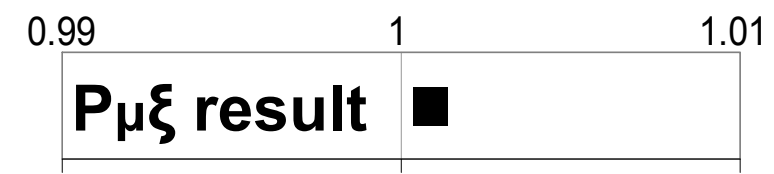
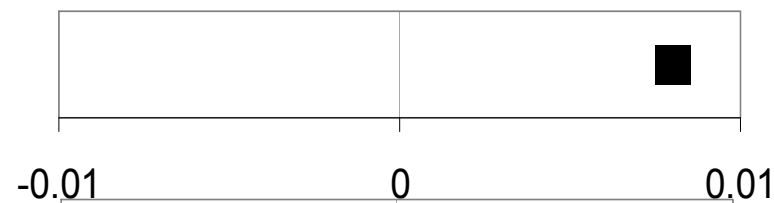
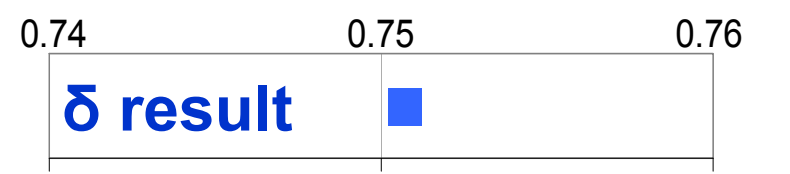
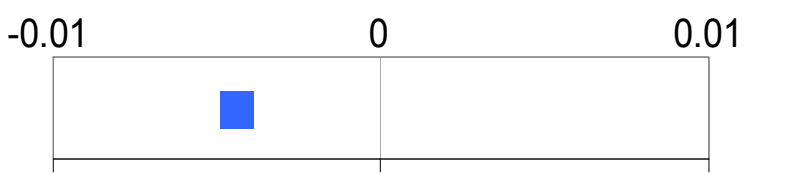
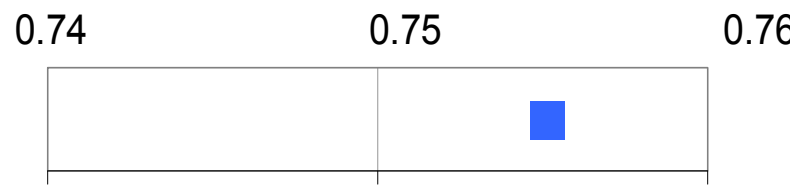

Corrections

(applied to data minus simulation, units 10^{-4})

Polarisation	Production target	+ 0.3 at 29.60 MeV/c
	multiple scattering	+ 1.6 at 28.85 MeV/c + 1.9 at 28.75 MeV/c
	Final relaxation rate	+ 2.7 for silver + 3.3 for aluminium

		ρ	δ	$P\mu\xi$
Unmatched statistics	Spectrum fitter	-0.2	-0.1	-0.5
	Energy calibration	-1.3	-0.3	+1.3
	(set dependent)	to	to	to
		-1.7	-0.5	+2.4

Parameter correlations

$$\text{corr}(\rho, \delta) = +0.69$$

$$\text{corr}(\rho, P\mu\xi) = -0.06 (+), -0.14 (-)$$

$$\text{corr}(\delta, P\mu\xi) = -0.18 (+), -0.43 (-)$$

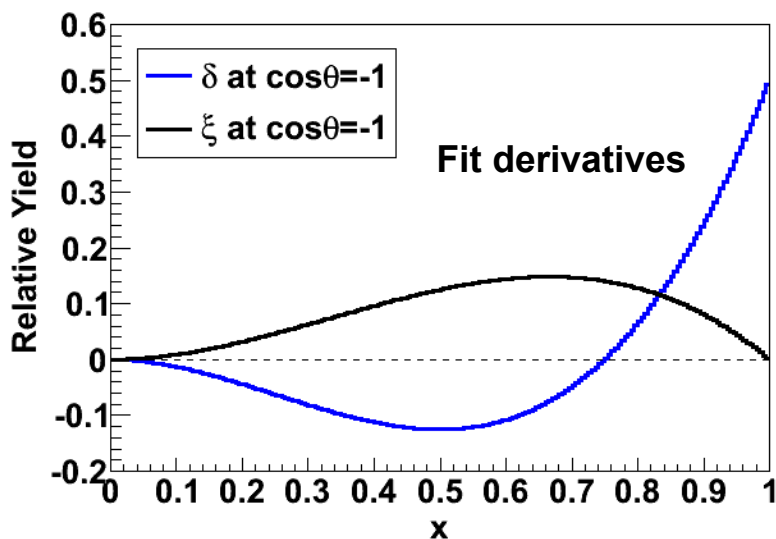
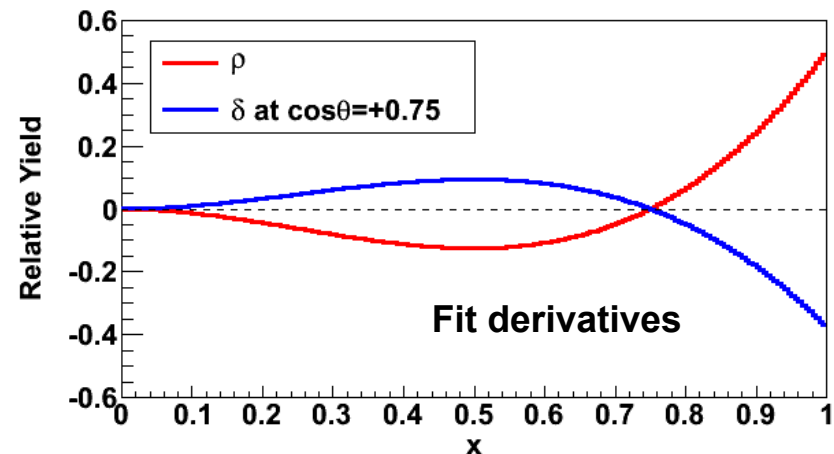
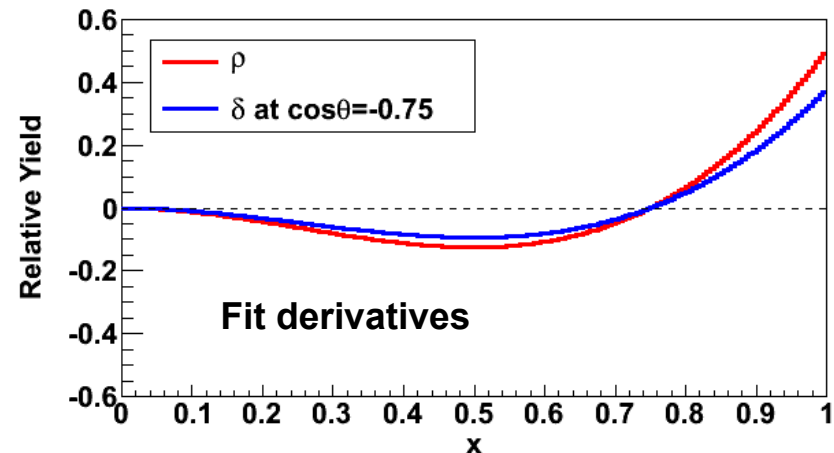

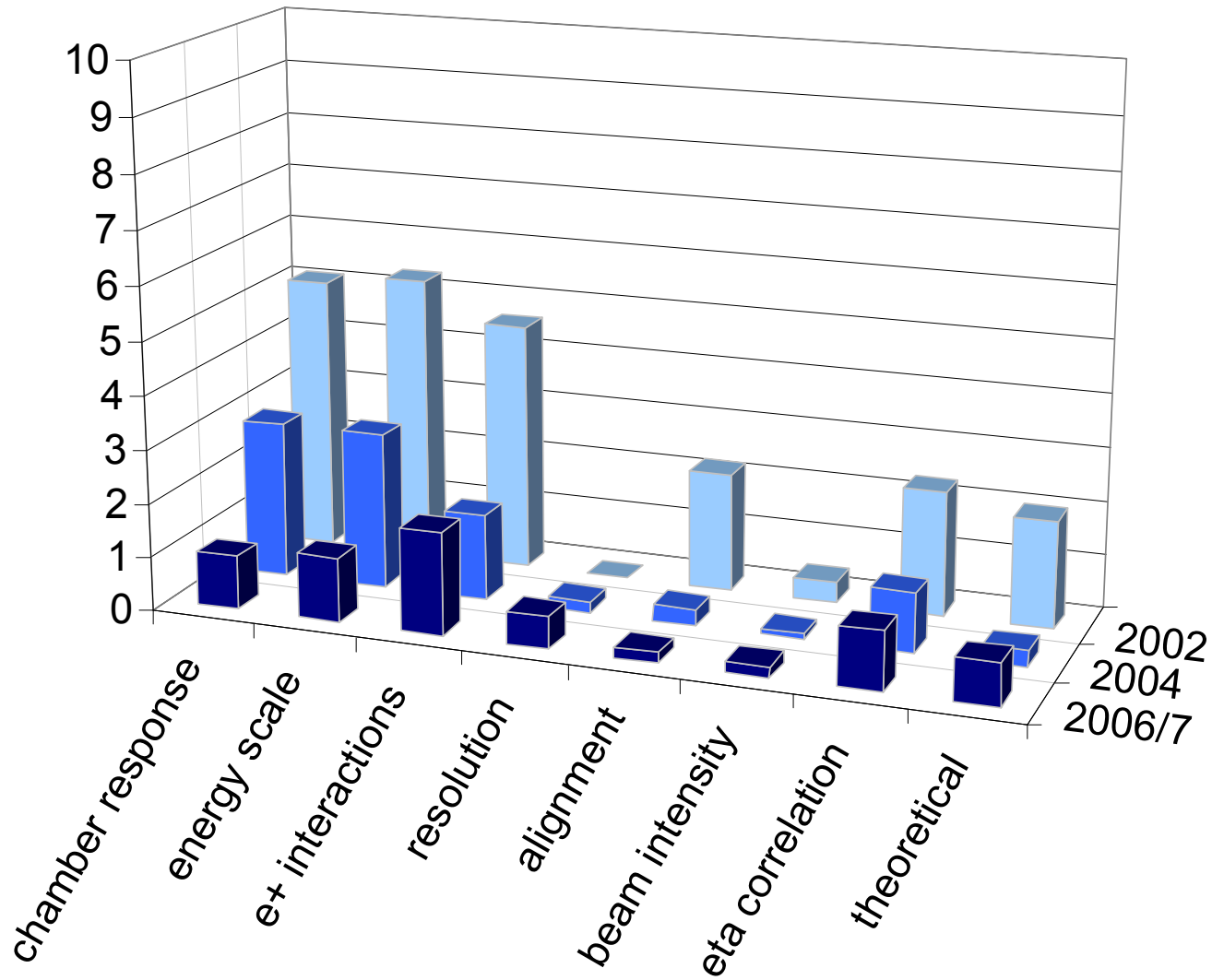

Improvement in systematic uncertainties: ρ

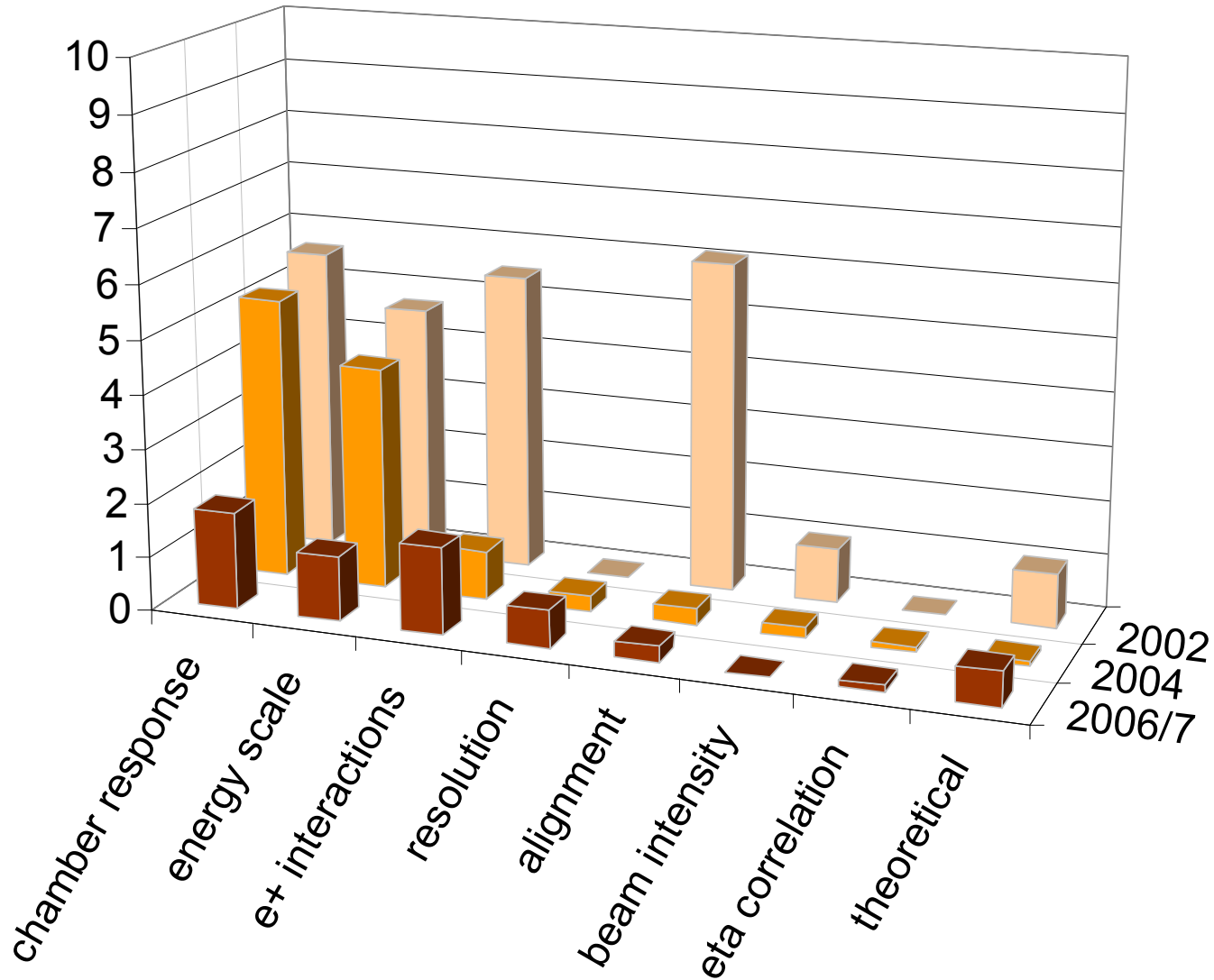

Improvement in systematic uncertainties: δ



Limits on LRS parameters: PDG08

Observable	m_2 (GeV/c ₂)	$ \zeta $		
$m(K_L^0)$ - $m(K_S^0)$	>700		reach	(P)MLRS
Direct W_R searches	>1000 (D0) >788 (CDF)		clear signal	(P)MLRS decay model
Electro- weak fit		<0.013	fit	(P)MLRS
β decay	>310	<0.040	both parameters	(P)MLRS light ν_R
μ decay*, <i>TWIST</i>	>475 (>530)	<0.021 (<0.016)	model independence	light ν_R

* in generalized LRS model; to be interpreted as $m_2(g_L/g_R)$, $\zeta(g_R/g_L)$.

Reconstruction inefficiency

